

CATALOGO
LIGHTING
2025



Indice

LAMPADINE A LED	8
3CCT	8
SMD	9
FILAMENTO	19
R7S	25
PROFESSIONALI	27
ACCESSORI LED - SENSORI E TIMER - CAVI	32
ADATTATORI e PORTALAMPADA	32
SENSORI DI PRESENZA	33
PRESE COMANDATE E TIMER	35
LAMPADE CON LENTE	37
CAVI COLORATI E PENDANT	38
PLAFONIERE LED e TUBI	42
PLAFONIERE A LED IP20	42
PLAFONIERE A LED IP44	49
PLAFONIERE A LED IP54	51
PLAFONIERE A LED IP65	52
TUBI A LED	57
SISTEMA LINEARE A LED	60
FARETTI ESTERNI E DA INCASSO A LED	64
DA INCASSO	64
ULTRASLIM	68
RICARICABILI	74
BINARI e accessori	78
2 PIN E ACCESSORI	78
4 PIN E ACCESSORI	79
LUCI SEGNAPASSO E EMERGENZA	84
PANNELLI LED	90
FARI PROFESSIONALI e accessori	94
PROFILI LED e accessori - DRIVER	104
PROFILI LED	104
STRISCE LED	109
MODULI LED	110
DRIVER LED	112



Legenda

	classe energetica calcolata sulle specifiche del fabbricante
	vita media h
	dimmerabile/non dimmerabile
	grado di protezione IP
	grado di abbagliamento luminoso
	grado di resistenza agli urti
	classe elettrica
	distorsione armonica
	efficienza luminosa
	mantenimento lumen (h)
	normativa
	normativa
	certificazione



ROHS



RAEE



certificato CE



Marchio qualità prodotti elettrici



NUOVI PRODOTTI 2025

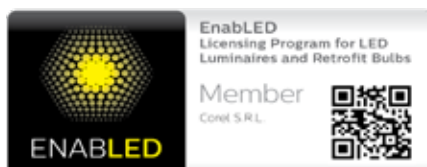

**COREL srl DAL 2023
E' PARTE DEL PROGRAMMA DI LICENZA
EnabLED by SIGNIFY**

**LAMPADINE
A LED**



Presentiamo la nostra esclusiva gamma di lampadine a LED, frutto di una continua ricerca dedicata alla qualità e all'efficienza energetica. Ogni prodotto è progettato per garantire non solo prestazioni energetiche elevate, ma anche un'estetica essenziale ed elegante, perfetta per ogni corpo illuminante.

We present our exclusive range of LED bulbs, a result of continuous research dedicated to quality and energy efficiency. Each product is designed to ensure not only high energy performance, but also a minimalist and elegant aesthetic, perfect for each luminaire.



serie 3Lsmart - tonalità luce selezionabile

materiale: Alluminio + Policarbonato

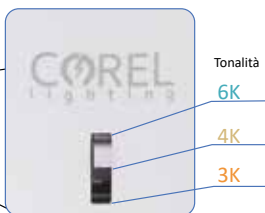

CODICE ARTICOLO	MODELLO	WATT	BASE	VOLT	LUMEN	KELVIN	ANGOLO	DIMM.	CRI	COLORE	TIPO LED	CLASSE ENERGETICA	IMBALLO
3L20	A60	12	E27	230	1070	3K-4K-6K	240°	NO	≥80	OPALE	SMD2835	F	10/50
3L30	A70	15	E27	230	1370	3K-4K-6K	240°	NO	≥80	OPALE	SMD2835	F	10/50
3L50	G45	6	E14	230	540	3K-4K-6K	240°	NO	≥80	OPALE	SMD2835	F	10/50
3L60	G45	6	E27	230	540	3K-4K-6K	240°	NO	≥80	OPALE	SMD2835	F	10/50
3L70	C37	6	E14	230	540	3K-4K-6K	240°	NO	≥80	OPALE	SMD2835	F	10/50
3L80	GU10	7	GU10	230	560	3K-4K-6K	240°	NO	≥80	OPALE	SMD2835	F	10/50
3L90	T44	12	E27	230	1050	3K-4K-6K	240°	NO	≥80	OPALE	SMD2835	F	10/50
3L100	T44	15	E27	230	1350	3K-4K-6K	240°	NO	≥80	OPALE	SMD2835	F	10/50
3L110	G95	14	E27	230	1400	3K-4K-6K	240°	NO	≥80	OPALE	SMD2835	F	6/18
3L120	G120	16	E27	230	1600	3K-4K-6K	240°	NO	≥80	OPALE	SMD2835	F	6/18
3L130	G150	18	E27	230	1800	3K-4K-6K	240°	NO	≥80	OPALE	SMD2835	F	6



GOCCIA A60 SMD

materiale: Alluminio + Policarbonato



CODICE ARTICOLO	WATT	BASE	VOLT	LUMEN	KELVIN	ANGOLO	CRI	COLORE	TIPO LED	CLASSE ENERGETICA	IMBALLO
LD5160	9	E27	230	820	3000	240°	≥80	OPALE	SMD 2835	F	10/50
LD5165	9	E27	230	820	4000	240°	≥80	OPALE	SMD 2835	F	10/50
LD5170	9	E27	230	820	6500	240°	≥80	OPALE	SMD 2835	F	10/50
LD5180	11	E27	230	1055	3000	240°	≥80	OPALE	SMD 2835	F	10/50
LD5185	11	E27	230	1055	4000	240°	≥80	OPALE	SMD 2835	F	10/50
LD5190	11	E27	230	1055	6500	240°	≥80	OPALE	SMD 2835	F	10/50
LD5600	15	E27	230	1521	3000	240°	≥80	OPALE	SMD 2835	F	10/50
LD5610	15	E27	230	1521	4000	240°	≥80	OPALE	SMD 2835	F	10/50
LD5620	15	E27	230	1521	6500	240°	≥80	OPALE	SMD 2835	F	10/50
LD5605	15	E27	230	1800	3000	200°	≥80	OPALE	SMD 2835	E	10/50
LD5615	15	E27	230	1800	4000	200°	≥80	OPALE	SMD 2835	E	10/50
LD5625	15	E27	230	1800	6500	200°	≥80	OPALE	SMD 2835	E	10/50

GOCCIA A60 SMD - 12V DC

materiale: Alluminio + Policarbonato



CODICE ARTICOLO	WATT	BASE	VOLT	LUMEN	KELVIN	ANGOLO	CRI	COLORE	TIPO LED	CLASSE ENERGETICA	IMBALLO
LD6000	9	E27	12V DC	750	3000	270°	≥80	OPALE	SMD 2835	G	10/50
LD6005	9	E27	12V DC	775	4000	270°	≥80	OPALE	SMD 2835	G	10/50
LD6010	12	E27	12V DC	1000	3000	270°	≥80	OPALE	SMD 2835	G	10/50
LD6015	12	E27	12V DC	1025	4000	270°	≥80	OPALE	SMD 2835	G	10/50



GOCCIA A60 SMD - SENSOR

materiale: Alluminio + Policarbonato



CODICE ARTICOLO	WATT	BASE	VOLT	LUMEN	KELVIN	ANGOLO	CRI	COLORE	TIPO LED	CLASSE ENERGETICA	IMBALLO
LD6100 SENSOR	11	E27	230	1055	4000	240°	≥80	OPALE	SMD 2835	F	10/50



GOCCIA A65 SMD

materiale: Alluminio + Policarbonato



CODICE ARTICOLO	WATT	BASE	VOLT	LUMEN	KELVIN	ANGOLO	CRI	COLORE	TIPO LED	CLASSE ENERGETICA	IMBALLO
LD5285	17	E27	230	1520	3000	180°	≥80	OPALE	SMD 2835		10/100
LD5650	20	E27	230	2452	3000	180°	≥80	OPALE	SMD 2835		10/50
LD5655	20	E27	230	2452	4000	220°	≥80	OPALE	SMD 2835		10/50
LD5660	20	E27	230	2452	6500	220°	≥80	OPALE	SMD 2835		10/50

MINIGLOBO G45 SMD

materiale: Alluminio + Policarbonato



CODICE ARTICOLO	WATT	BASE	VOLT	LUMEN	KELVIN	ANGOLO	CRI	COLORE	TIPO LED	CLASSE ENERGETICA	IMBALLO
LD5120	5	E14	230	400	3000	220°	≥80	OPALE	SMD 2835		10/50
LD5125	5	E14	230	400	4000	220°	≥80	OPALE	SMD 2835		10/50
LD5130	5	E14	230	400	6500	220°	≥80	OPALE	SMD 2835		10/50
LD5030	7	E14	230	600	6500	220°	≥80	OPALE	SMD 2835		10/50
LD5930	8	E14	230	806	3000	220°	≥80	OPALE	SMD 2835		10/50
LD5935	8	E14	230	806	4000	220°	≥80	OPALE	SMD 2835		10/50
LD5950	8	E14	230	806	6500	220°	≥80	OPALE	SMD 2835		10/50



CODICE ARTICOLO	WATT	BASE	VOLT	LUMEN	KELVIN	ANGOLO	CRI	COLORE	TIPO LED	CLASSE ENERGETICA	IMBALLO
LD5045	7	E27	230	600	4000	220°	≥80	OPALE	SMD 2835		10/50
LD5940	8	E27	230	806	3000	220°	≥80	OPALE	SMD 2835		10/50
LD5945	8	E27	230	806	4000	220°	≥80	OPALE	SMD 2835		10/50
LD5960	8	E27	230	806	6500	220°	≥80	OPALE	SMD 2835		10/50



CANDELA C37 SMD

materiale: Alluminio + Policarbonato



CODICE ARTICOLO	WATT	BASE	VOLT	LUMEN	KELVIN	ANGOLO	CRI	COLORE	TIPO LED	CLASSE ENERGETICA	IMBALLO
LD5105	5	E14	230	400	4000	220°	≥80	OPALE	SMD 2835		10/50
LD5000	7	E14	230	600	3000	220°	≥80	OPALE	SMD 2835		10/50
LD5005	7	E14	230	600	4000	220°	≥80	OPALE	SMD 2835		10/50
LD5010	7	E14	230	550	6500	220°	≥80	OPALE	SMD 2835		10/50



CODICE ARTICOLO	WATT	BASE	VOLT	LUMEN	KELVIN	ANGOLO	CRI	COLORE	TIPO LED	CLASSE ENERGETICA	IMBALLO
LD5920	8	E14	230	806	3000	220°	≥80	OPALE	SMD 2835		10/50
LD5925	8	E14	230	806	4000	220°	≥80	OPALE	SMD 2835		10/50
LD5915	8	E14	230	806	6500	220°	≥80	OPALE	SMD 2835		10/50

FIAMMA C35 SMD

materiale: Alluminio + Policarbonato



CODICE ARTICOLO	WATT	BASE	VOLT	LUMEN	KELVIN	ANGOLO	CRI	COLORE	TIPO LED	CLASSE ENERGETICA	IMBALLO
LD5080	4	E14	230	320	3000	220°	≥80	OPALE	SMD 2835		10/50
LD5090	5	E14	230	400	6500	220°	≥80	OPALE	SMD 2835		10/50

T50 SMD

materiale: Alluminio + Policarbonato



CODICE ARTICOLO	WATT	BASE	VOLT	LUMEN	KELVIN	ANGOLO	CRI	COLORE	TIPO LED	CLASSE ENERGETICA	IMBALLO
LD9080	8	E14	230	800	3000	220°	≥80	OPALE	SMD 2835		10/50
LD9085	8	E14	230	800	4000	220°	≥80	OPALE	SMD 2835		10/50



GLOBO G95 SMD

materiale: Alluminio + Policarbonato

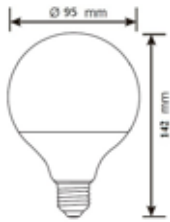

CODICE ARTICOLO	WATT	BASE	VOLT	LUMEN	KELVIN	ANGOLO	CRI	COLORE	TIPO LED	CLASSE ENERGETICA	IMBALLO
LD5630	12	E27	230	1300	3000	360°	≥80	OPALE	SMD 2835	F	6/12



GLOBO G120 SMD

materiale: Alluminio + Policarbonato

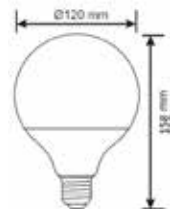

CODICE ARTICOLO	WATT	BASE	VOLT	LUMEN	KELVIN	ANGOLO	CRI	COLORE	TIPO LED	CLASSE ENERGETICA	IMBALLO
LD4000	18	E27	230	1850	3000	240°	≥80	OPALE	SMD 5730	F	1/25



RIFLETTORE R50 SMD

materiale: Alluminio + Policarbonato



CODICE ARTICOLO	WATT	BASE	VOLT	LUMEN	KELVIN	ANGOLO	CRI	COLORE	TIPO LED	CLASSE ENERGETICA	IMBALLO
LD5200	6	E14	230	480	3000	120°	≥80	OPALE	SMD 5730		10/50
LD5205	6	E14	230	480	4000	120°	≥80	OPALE	SMD 5730		10/50
LD5210	6	E14	230	480	6500	120°	≥80	OPALE	SMD 5730		10/50



RIFLETTORE R63 SMD

materiale: Alluminio + Policarbonato



CODICE ARTICOLO	WATT	BASE	VOLT	LUMEN	KELVIN	ANGOLO	CRI	COLORE	TIPO LED	CLASSE ENERGETICA	IMBALLO
LD5220	8	E27	230	720	3000	120°	≥80	OPALE	SMD 5730		10/50
LD5215	8	E27	230	630	4000	120°	≥80	OPALE	SMD 5730		10/50
LD5230	8	E27	230	630	6500	120°	≥80	OPALE	SMD 5730		10/50



RIFLETTORE R80 SMD

materiale: Alluminio + Policarbonato



CODICE ARTICOLO	WATT	BASE	VOLT	LUMEN	KELVIN	ANGOLO	CRI	COLORE	TIPO LED	CLASSE ENERGETICA	IMBALLO
LD5970	12	E27	230	960	3000	160°	≥80	OPALE	SMD 5730		10/50
LD5980	12	E27	230	960	4000	160°	≥80	OPALE	SMD 5730		10/50



SPOT LIGHT GU10 SMD

materiale: Alluminio + Policarbonato



CODICE ARTICOLO	WATT	BASE	VOLT	DIMM.	LUMEN	KELVIN	ANGOLO	CRI	COLORE	TIPO LED	CLASSE ENERGETICA	IMBALLO
LD5240	7	GU10	230	NO	510	3000	38°	≥80	CHIARA	SMD 2835	F	10/50
LD5245	7	GU10	230	NO	510	4000	38°	≥80	CHIARA	SMD 2835	F	10/50
LD5250	7	GU10	230	NO	510	6500	38°	≥80	CHIARA	SMD 2835	F	10/50
LD5360	7	GU10	230	NO	600	3000	110°	≥80	OPALE	SMD 2835	F	10/50
• LD5365	7	GU10	230	SI	600	3000	110°	≥80	OPALE	SMD 2835	F	10/50
LD5370	7	GU10	230	NO	600	4000	110°	≥80	OPALE	SMD 2835	F	10/50
LD5380	7	GU10	230	NO	600	6500	100°	≥80	OPALE	SMD 2835	F	10/50



RIFLETTORE PAR30 SMD

materiale: Alluminio + Policarbonato

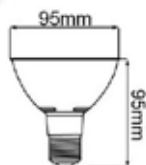

CODICE ARTICOLO	WATT	BASE	VOLT	LUMEN	KELVIN	ANGOLO	CRI	COLORE	TIPO LED	CLASSE ENERGETICA	IMBALLO
LD5410	13	E27	230	850	3000	25°	≥80	OPALE	SMD 3030	G	10/40
• LD5415	13	E27	230	900	4000	25°	≥80	OPALE	SMD 3030	G	10/40
LD5420	13	E27	230	900	6500	25°	≥80	OPALE	SMD 3030	G	10/40



SPOT LIGHT AR111 SMD

materiale: Alluminio + Policarbonato

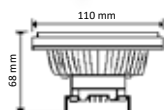

CODICE ARTICOLO	WATT	BASE	VOLT	LUMEN	KELVIN	ANGOLO	CRI	COLORE	TIPO LED	CLASSE ENERGETICA	IMBALLO
LD5325	15	G53	12V AC/DC	950	3000	45°	≥80	CHIARA	SMD 2835	G	10/100



RIFLETTORE GX53 SMD

materiale: Alluminio + Policarbonato



CODICE ARTICOLO	WATT	BASE	VOLT	LUMEN	KELVIN	ANGOLO	CRI	COLORE	TIPO LED	CLASSE ENERGETICA	IMBALLO
LD5340	8	GX53	230	720	3000	120°	≥80	OPALE	SMD 2835	G	10/40
LD5350	8	GX53	230	650	4200	120°	≥80	OPALE	SMD 2835	G	10/40

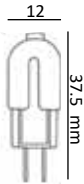

G4 SMD - POLICARBONATO

materiale: Alluminio + Policarbonato



CODICE ARTICOLO	WATT	BASE	VOLT	LUMEN	KELVIN	ANGOLO	CRI	COLORE	TIPO LED	CLASSE ENERGETICA	IMBALLO
• LD7010	1.2	G4	12V AC/DC	135	3000	300°	≥80	OPALE	SMD 2835		50/500

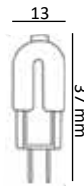

G4 SMD - POLICARBONATO

materiale: Alluminio + Policarbonato



CODICE ARTICOLO	WATT	BASE	VOLT	LUMEN	KELVIN	ANGOLO	CRI	COLORE	TIPO LED	CLASSE ENERGETICA	IMBALLO
LD7011	2	G4	12V AC/DC	250	3000	300°	≥80	CHIARA	SMD 2835		50/500

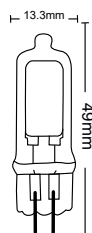

G4 SMD - VETRO

materiale: VETRO



CODICE ARTICOLO	WATT	BASE	VOLT	LUMEN	KELVIN	ANGOLO	CRI	COLORE	TIPO LED	CLASSE ENERGETICA	IMBALLO
• LD7012	2	G4	12V AC/DC	200	3000	360°	≥80	CHIARA	SMD 2835		50/500



G9 SMD 2W

materiale: Alluminio + Policarbonato



CODICE ARTICOLO	WATT	BASE	VOLT	LUMEN	KELVIN	ANGOLO	CRI	COLORE	TIPO LED	CLASSE ENERGETICA	IMBALLO
● LD7000	2	G9	230	200	3000	360°	≥80	CHIARA	SMD 2835		100/500
LD7005	2,5	G9	230	230	4000	360°	≥80	CHIARA	SMD 2835		100/500

G9 SMD CERAMICA

materiale: Ceramica + Policarbonato



CODICE ARTICOLO	WATT	BASE	VOLT	LUMEN	KELVIN	DIMM.	ANGOLO	CRI	COLORE	TIPO LED	CLASSE ENERGETICA	IMBALLO
LD7020	3,5	G9	230	360	2700	NO	300°	≥80	CHIARA	SMD 2835		50/500
LD7025	4,5	G9	230	380	4000	NO	360°	≥80	CHIARA	SMD 2835		100/500
● LD7050	4,5	G9	230	450	3000	SI	360°	≥80	CHIARA	SMD 2835		100/500

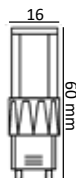

CODICE ARTICOLO	WATT	BASE	VOLT	LUMEN	KELVIN	ANGOLO	CRI	COLORE	TIPO LED	CLASSE ENERGETICA	IMBALLO
LD7040	4,5	G9	230	450	2700	300°	≥80	CHIARA	SMD 2835		100/500

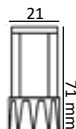

CODICE ARTICOLO	WATT	BASE	VOLT	LUMEN	KELVIN	ANGOLO	CRI	COLORE	TIPO LED	CLASSE ENERGETICA	IMBALLO
● LD7070	7	G9	230	750	3000	300°	≥80	CHIARA	SMD 2835		100/500



CODICE ARTICOLO	WATT	BASE	VOLT	LUMEN	KELVIN	ANGOLO	CRI	COLORE	TIPO LED	CLASSE ENERGETICA	IMBALLO
● LD7080	7	G9	230	1000	3000	300°	≥80	CHIARA	SMD 2835		100/500

G9 COB ALL GLASS

materiale: Vetro



CODICE ARTICOLO	WATT	BASE	VOLT	LUMEN	KELVIN	ANGOLO	DIMM.	CRI	COLORE	TIPO LED	CLASSE ENERGETICA	IMBALLO
LD1520	4	G9	230	470	3000	360°	NO	≥80	OPALE	COB		100/500
LD1515	3,5	G9	230	400	4000	360°	NO	≥80	CHIARA	COB		100/500
LD1525	3,5	G9	230	400	4000	360°	NO	≥80	OPALE	COB		100/500
LD7060	4	G9	230	470	3000	360°	NO	≥80	CHIARA	COB		100/500
LD7065	4	G9	230	470	4000	360°	NO	≥80	CHIARA	COB		100/500



● LD7085	4	G9	230	470	3000	360°	SI	≥80	CHIARA	COB		100/500
● LD7090	4	G9	230	470	3000	360°	NO	≥80	CHIARA	COB		100/500
● LD7095	4	G9	230	470	4000	360°	NO	≥80	CHIARA	COB		100/500



T16 SMD

materiale: Ceramica + Policarbonato

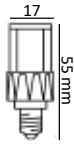

CODICE ARTICOLO	WATT	BASE	VOLT	LUMEN	KELVIN	DIMM.	ANGOLO	CRI	COLORE	TIPO LED	CLASSE ENERGETICA	IMBALLO
LD7030	4,5	E14	230	380	2700	NO	360°	≥80	CHIARA	SMD 2835		100/500

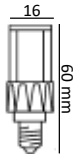

CODICE ARTICOLO	WATT	BASE	VOLT	LUMEN	KELVIN	DIMM.	ANGOLO	CRI	COLORE	TIPO LED	CLASSE ENERGETICA	IMBALLO
LD7055	4	E14	230	450	4000	NO	360°	≥80	CHIARA	SMD 2835		50/500



T16 COB ALL GLASS

materiale: Vetro



CODICE ARTICOLO	WATT	BASE	VOLT	LUMEN	KELVIN	ANGOLO	CRI	COLORE	TIPO LED	CLASSE ENERGETICA	IMBALLO
LD1530	3	E14	230	400	3000	360°	≥80	CHIARA	COB		10/50
LD1540	3	E14	230	400	4000	360°	≥80	CHIARA	COB		10/50
LD1560	3	E14	230	400	4000	360°	≥80	OPALE	COB		10/50



A60 SMD full glass

materiale: Vetro



CODICE ARTICOLO	WATT	BASE	VOLT	LUMEN	KELVIN	ANGOLO	CRI	COLORE	TIPO LED	CLASSE ENERGETICA	IMBALLO
LD360-84	8	E27	230	800	4000	360°	≥80	OPALE	SMD2835		10/50



C35 SMD full glass

materiale: Vetro



CODICE ARTICOLO	WATT	BASE	VOLT	LUMEN	KELVIN	ANGOLO	CRI	COLORE	TIPO LED	CLASSE ENERGETICA	IMBALLO
LD360-353	3,5	E14	230	300	3000	360°	≥80	OPALE	SMD2835		10/100
LD360-354	3,5	E14	230	300	4000	360°	≥80	OPALE	SMD2835		10/100



G45 SMD full glass

materiale: Vetro



CODICE ARTICOLO	WATT	BASE	VOLT	LUMEN	KELVIN	ANGOLO	CRI	COLORE	TIPO LED	CLASSE ENERGETICA	IMBALLO
LD360-454	3,5	E14	230	300	4000	360°	≥80	OPALE	SMD2835		10/100



A60 filamento CHIARA

materiale: Vetro



CODICE ARTICOLO	WATT	BASE	VOLT	LUMEN	KELVIN	ANGOLO	CRI	COLORE	TIPO LED	CLASSE ENERGETICA	IMBALLO
LD8010	6	E27	230	630	4000	360°	≥80	CHIARA	filamento		10/100
LD8005	7	E27	230	806	3000	360°	≥80	CHIARA	filamento		10/100
LD8015	7,5	E27	230	806	4000	360°	≥80	CHIARA	filamento		10/100
LD8008	8	E27	230	1055	3000	360°	≥80	CHIARA	filamento		10/100
LD8011	8	E27	230	1055	4000	360°	≥80	CHIARA	filamento		10/100
LD8012	11	E27	230	1521	3000	360°	≥80	CHIARA	filamento		10/100
LD8013	11	E27	230	1521	4000	360°	≥80	CHIARA	filamento		10/100



A60 filamento OPALE

materiale: Vetro



CODICE ARTICOLO	WATT	BASE	VOLT	LUMEN	KELVIN	ANGOLO	CRI	COLORE	TIPO LED	CLASSE ENERGETICA	IMBALLO
LD8400	6	E27	230	560	3000	360°	≥80	OPALE	filamento		10/100
LD8405	7	E27	230	806	3000	360°	≥80	OPALE	filamento		10/100
LD8415	7	E27	230	806	4000	360°	≥80	OPALE	filamento		10/100
LD8408	8	E27	230	1055	3000	360°	≥80	OPALE	filamento		10/100
LD8411	8	E27	230	1055	4000	360°	≥80	OPALE	filamento		10/100
LD8412	11	E27	230	1521	3000	360°	≥80	OPALE	filamento		10/100
LD8413	11	E27	230	1521	4000	360°	≥80	OPALE	filamento		10/100



A68 filamento CHIARA

materiale: Vetro



CODICE ARTICOLO	WATT	BASE	VOLT	LUMEN	KELVIN	ANGOLO	CRI	COLORE	TIPO LED	CLASSE ENERGETICA	IMBALLO
LD8014	13	E27	230	1800	3000	360°	≥80	CHIARA	filamento		10/60
LD8016	13	E27	230	1800	4000	360°	≥80	CHIARA	filamento		10/v0



A68 filamento OPALE

materiale: Vetro



CODICE ARTICOLO	WATT	EQ. WATT	BASE	VOLT	LUMEN	KELVIN	ANGOLO	CRI	COLORE	TIPO LED	CLASSE ENERGETICA	IMBALLO
• LD8414	13	115	E27	230	1800	3000	360°	≥80	OPALE	filamento		10/100
• LD8416	13	115	E27	230	1800	4000	360°	≥80	OPALE	filamento		10/100



G45 filamento miniglobo CHIARA

materiale: Vetro

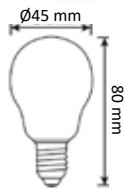

CODICE ARTICOLO	WATT	BASE	VOLT	LUMEN	KELVIN	ANGOLO	CRI	COLORE	TIPO LED	CLASSE ENERGETICA	IMBALLO
LD8060	4	E14	230	470	3000	360°	≥80	CHIARA	filamento		10/100
LD8070	4	E14	230	470	4000	360°	≥80	CHIARA	filamento		10/100
• LD8248	5	E14	230	600	3000	360°	≥80	CHIARA	filamento		10/100
LD8306	6	E14	230	806	3000	360°	≥80	CHIARA	filamento		10/100

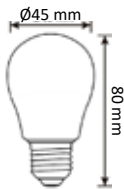

CODICE ARTICOLO	WATT	BASE	VOLT	LUMEN	KELVIN	ANGOLO	CRI	COLORE	TIPO LED	CLASSE ENERGETICA	IMBALLO
LD8080	4	E27	230	470	3000	360°	≥80	CHIARA	filamento		10/100
LD8090	3,6	E27	230	360	4000	360°	≥80	CHIARA	filamento		10/100
LD8307	6	E27	230	806	3000	360°	≥80	CHIARA	filamento		10/100
LD8308	6	E27	230	806	4000	360°	≥80	CHIARA	filamento		10/100



G45 filamento miniglobo OPALE

materiale: Vetro

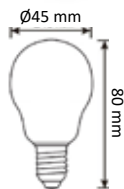

CODICE ARTICOLO	WATT	BASE	VOLT	LUMEN	KELVIN	ANGOLO	CRI	COLORE	TIPO LED	CLASSE ENERGETICA	IMBALLO
LD8460	4	E14	230	390	3000	360°	≥80	OPALE	filamento		10/100
LD8470	4	E14	230	390	4000	360°	≥80	OPALE	filamento		10/100
LD8506	6	E14	230	806	3000	360°	≥80	OPALE	filamento		10/100

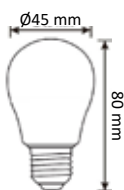

CODICE ARTICOLO	WATT	BASE	VOLT	LUMEN	KELVIN	ANGOLO	CRI	COLORE	TIPO LED	CLASSE ENERGETICA	IMBALLO
LD8490	3,6	E27	230	390	4000	360°	≥80	OPALE	filamento		10/100
LD8507	6	E27	230	700	3000	360°	≥80	OPALE	filamento		10/100
LD8508	6	E27	230	806	4000	360°	≥80	OPALE	filamento		10/100



A60/G45 filamento HALF SILVER

materiale: Vetro

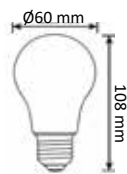

CODICE ARTICOLO	WATT	BASE	VOLT	LUMEN	KELVIN	ANGOLO	CRI	COLORE	TIPO LED	CLASSE ENERGETICA	IMBALLO
LD8950	9	E27	230	1200	3000	360°	≥80	HALF-SILVER	filamento		10/100

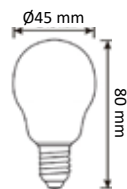

CODICE ARTICOLO	WATT	BASE	VOLT	LUMEN	KELVIN	ANGOLO	CRI	COLORE	TIPO LED	CLASSE ENERGETICA	IMBALLO
LD8960	5	E14	230	550	3000	360°	≥80	HALF-SILVER	filamento		10/100



ST64 filamento vintage

materiale: Vetro



CODICE ARTICOLO	WATT	BASE	VOLT	LUMEN	KELVIN	ANGOLO	CRI	COLORE	TIPO LED	CLASSE ENERGETICA	IMBALLO
LD8910	7,5	E27	230	800	2700	360°	≥80	CHIARA	filamento		1/50
LD8900	5	E27	230	450	2700	360°	≥80	GOLD	filamento		1/50
LD8920	7,5	E27	230	675	2700	360°	≥80	GOLD	filamento		1/50



C35 filamento candela CHIARA

materiale: Vetro



CODICE ARTICOLO	WATT	BASE	VOLT	LUMEN	KELVIN	ANGOLO	CRI	COLORE	TIPO LED	CLASSE ENERGETICA	IMBALLO
LD8020	4	E14	230	470	3000	360°	≥80	CHIARA	filamento		10/100
LD8048	5	E14	230	600	3000	360°	≥80	CHIARA	filamento		10/100
LD8006	6	E14	230	806	3000	360°	≥80	CHIARA	filamento		10/100



C35 filamento candela OPALE

materiale: Vetro



CODICE ARTICOLO	WATT	BASE	VOLT	LUMEN	KELVIN	ANGOLO	CRI	COLORE	TIPO LED	CLASSE ENERGETICA	IMBALLO
LD8420	4	E14	230	470	3000	360°	≥80	OPALE	filamento		10/100
LD8430	3,6	E14	230	320	4000	360°	≥80	OPALE	filamento		10/100
LD8406	6	E14	230	700	3000	360°	≥80	OPALE	filamento		10/100



G95 filamento globo

materiale: Vetro



CODICE ARTICOLO	WATT	BASE	VOLT	LUMEN	KELVIN	ANGOLO	CRI	COLORE	TIPO LED	CLASSE ENERGETICA	IMBALLO
LD8138	8	E27	230	1055	3000	360°	≥80	CHIARA	filamento	E	1/10



G125 filamento globo DIMMERABILE

materiale: Vetro



CODICE ARTICOLO	WATT	BASE	VOLT	LUMEN	KELVIN	ANGOLO	CRI	COLORE	TIPO LED	CLASSE ENERGETICA	IMBALLO
LD8160	4	E27	230	470	3000	360°	≥80	CHIARA	filamento	E	1/10
LD8605	18	E27	230	1800	3000	360°	≥80	OPALE	filamento	E	1/10
LD8600	24	E27	230	4000	3000	360°	≥80	OPALE	filamento	E	1/10



G125 filamento globo

materiale: Vetro

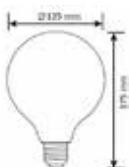

CODICE ARTICOLO	WATT	BASE	VOLT	LUMEN	KELVIN	ANGOLO	CRI	COLORE	TIPO LED	CLASSE ENERGETICA	IMBALLO
LD8570	11	E27	230	1521	3000	360°	≥80	CHIARA	filamento	D	1/25

CODICE ARTICOLO	WATT	BASE	VOLT	LUMEN	KELVIN	ANGOLO	CRI	COLORE	TIPO LED	CLASSE ENERGETICA	IMBALLO
LD8560	7,5	E27	230	750	4000	360°	≥80	OPALE	filamento	F	1/12
LD8580	12	E27	230	1521	3000	360°	≥80	OPALE	filamento	F	1/10



R7S slim led ALL GLASS

materiale: Vetro



CODICE ARTICOLO	WATT	BASE	VOLT	LUMEN	KELVIN	ANGOLO	CRI	COLORE	TIPO LED	CLASSE ENERGETICA	IMBALLO
LD9300	8,5	R7S	230	1055	3000	360°	≥80	CHIARA	COB		1/250
● LD9400	9	R7S	230	1055	3000	360°	≥80	CHIARA	COB		1/100
● LD9410	9	R7S	230	1055	4000	360°	≥80	CHIARA	COB		1/100



R7S SMD

materiale: Ceramica + Policarbonato

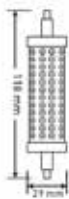

CODICE ARTICOLO	WATT	BASE	VOLT	LUMEN	KELVIN	ANGOLO	CRI	COLORE	TIPO LED	CLASSE ENERGETICA	IMBALLO
LD9500	16	R7S	230	2100	3000	360°	≥80	CHIARA	SMD2835		1/100
LD9505	16	R7S	230	2100	4000	360°	≥80	CHIARA	SMD2835		1/100

R7S slim led HI-PERFORMANCE

materiale: Ceramica + Policarbonato

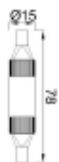

CODICE ARTICOLO	WATT	BASE	VOLT	LUMEN	KELVIN	ANGOLO	CRI	COLORE	TIPO LED	CLASSE ENERGETICA	IMBALLO
LD9015	4,9	R7S	230	910	3000	300°	≥80	CHIARA	SMD 2835		25/100



CODICE ARTICOLO	WATT	BASE	VOLT	LUMEN	KELVIN	ANGOLO	CRI	COLORE	TIPO LED	CLASSE ENERGETICA	IMBALLO
LD9016	8	R7S	230	1480	3000	300°	≥80	CHIARA	SMD 2835		25/100





R7S slim led

materiale: Ceramica + Policarbonato



CODICE ARTICOLO	WATT	BASE	VOLT	LUMEN	KELVIN	ANGOLO	CRI	COLORE	TIPO LED	CLASSE ENERGETICA	IMBALLO
LD9000	5	R7S	230	700	3000	360°	≥80	CHIARA	SMD 2835		25/100
LD9010	5	R7S	230	780	4000	360°	≥80	CHIARA	SMD 2835		25/100
LD9005	7	R7S	230	1000	3000	300°	≥80	CHIARA	SMD 2835		25/100
CODICE ARTICOLO	WATT	BASE	VOLT	LUMEN	KELVIN	ANGOLO	CRI	COLORE	TIPO LED	CLASSE ENERGETICA	IMBALLO
LD9025	11	R7S	230	1600	3000	300°	≥80	CHIARA	SMD 2835		25/100
LD9035	11	R7S	230	1700	4000	300°	≥80	CHIARA	SMD 2835		25/100

R7S evo

materiale: Ceramica + Policarbonato



CODICE ARTICOLO	WATT	BASE	VOLT	LUMEN	KELVIN	ANGOLO	CRI	COLORE	TIPO LED	CLASSE ENERGETICA	IMBALLO
LD9280	9	R7S	230	1220	3000	330°	≥80	CHIARA	SMD 2835		25/100
LD9290	9	R7S	230	1350	4000	330°	≥80	CHIARA	SMD 2835		25/100
CODICE ARTICOLO	WATT	BASE	VOLT	LUMEN	KELVIN	ANGOLO	CRI	COLORE	TIPO LED	CLASSE ENERGETICA	IMBALLO
LD9260	16	R7S	230	2160	3000	330°	≥80	CHIARA	SMD 2835		25/100
LD9270	16	R7S	230	2300	4000	330°	≥80	CHIARA	SMD 2835		25/100

R7S ceraled plus

materiale: Ceramica + Policarbonato



CODICE ARTICOLO	WATT	BASE	VOLT	LUMEN	KELVIN	ANGOLO	CRI	COLORE	TIPO LED	CLASSE ENERGETICA	IMBALLO
LD9050	9	R7S	230	980	4000	360°	≥80	CHIARA	SMD 2835		25/100
CODICE ARTICOLO	WATT	BASE	VOLT	LUMEN	KELVIN	ANGOLO	CRI	COLORE	TIPO LED	CLASSE ENERGETICA	IMBALLO
LD9070	17	R7S	230	1800	4000	360°	≥80	CHIARA	SMD 2835		25/100



BULBO COB

materiale: Vetro

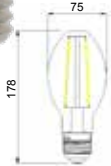

CODICE ARTICOLO	WATT	BASE	VOLT	LUMEN	KELVIN	ANGOLO	CRI	COLORE	TIPO LED	CLASSE ENERGETICA	IMBALLO
LD20020	20	E27	230	2500	3000	360°	≥80	CHIARA	COB		1/25
LD20021	20	E27	230	2500	4000	360°	≥80	CHIARA	COB		1/25
LD20022	20	E27	230	2250	4000	360°	≥80	OPALE	COB		1/25



CODICE ARTICOLO	WATT	BASE	VOLT	LUMEN	KELVIN	ANGOLO	CRI	COLORE	TIPO LED	CLASSE ENERGETICA	IMBALLO
LD20030	30	E27	230	4500	3000	360°	≥80	CHIARA	COB		1/25
LD20031	30	E27	230	4500	4000	360°	≥80	CHIARA	COB		1/25
LD20050	40	E27	230	5500	4000	360°	≥80	CHIARA	COB		1/25
LD20051	40	E27	230	5500	5000	360°	≥80	CHIARA	COB		1/25



TUBOLARE COB

materiale: Vetro

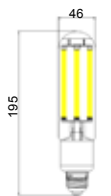

CODICE ARTICOLO	WATT	BASE	VOLT	LUMEN	KELVIN	ANGOLO	CRI	COLORE	TIPO LED	CLASSE ENERGETICA	IMBALLO
LD20040	20	E27	230	3000	3000	360°	≥80	CHIARA	COB		1/25
LD20041	20	E27	230	3000	4000	360°	≥80	CHIARA	COB		1/25



ALTA POTENZA SMD 100-240V

materiale: Alluminio + Policarbonato



CARATTERISTICHE TECNICHE:

- VENTOLA SILENZIOSA DI RAFFREDDAMENTO
- CIRCUITO TERMICO A RIPRISTINO AUTOMATICO (interviene in caso di temperature oltre i 50°C)

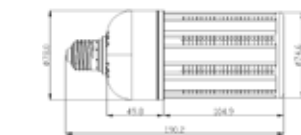

CODICE ARTICOLO	WATT	BASE	VOLT	LUMEN	KELVIN	ANGOLO	CRI	COLORE	TIPO LED	CLASSE ENERGETICA	IMBALLO
LD10021	20	E27	100	2500	3000	300°	≥80	CHIARA	SMD2835		1/24

LD10020	20	E27	100	2500	4000	300°	≥80	CHIARA	SMD2835		1/24
----------------	----	-----	-----	------	------	------	-----	--------	---------	--	------

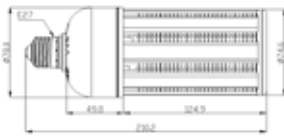

LD10031	30	E27	100	3600	3000	300°	≥80	CHIARA	SMD2835		1/24
----------------	----	-----	-----	------	------	------	-----	--------	---------	--	------

LD10030	30	E27	100	3600	4000	300°	≥80	CHIARA	SMD2835		1/24
----------------	----	-----	-----	------	------	------	-----	--------	---------	--	------

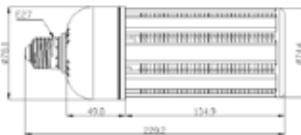

LD10040	40	E27	100	4800	4000	300°	≥80	CHIARA	SMD2835		1/24
----------------	----	-----	-----	------	------	------	-----	--------	---------	--	------



**ACCESSORI LED
CAVI PER ILLUMINAZIONE
LAMPAD E CON LENTE**



Progettati per migliorare l'efficienza e la praticità delle lampade a LED, i nostri sensori di presenza, timer e adattatori offrono flessibilità nella programmazione e nell'uso dei dispositivi LED.

I nostri accessori promuovono anche la sostenibilità, trasformando ogni ambiente in uno spazio più efficiente e accogliente.

Designed to improve the efficiency and utility of LED lamps, our presence sensors, timers and adapters offer flexibility in the programming and use of LED devices.

Our accessories also promote sustainability, transforming any room into a more efficient and welcoming space.



ADATTATORI/PORTALAMPADA

materiale: Alluminio + Policarbonato

230V MAX

	CODICE ARTICOLO	DESCRIZIONE	ATTACCO	COLORE	IMBALLO
	AD1427	ADATTATORE DA E14 A E27	E14	BIANCO	50/200
	AD2714	ADATTATORE DA E27 A E14	E27	BIANCO	10/250
	AD2740	ADATTATORE DA E27 A E40	E27	BIANCO	10/250
	AD4027	ADATTATORE DA E40 A E27	E40	BIANCO	10/250
	AD14GU10	ADATTATORE DA E14 A GU10	E14	BIANCO	12/600
	AD27GU10	ADATTATORE DA E27 A GU10	E27	BIANCO	10/250
	ADGU10G9	ADATTATORE DA GU10 A G9	GU10	BIANCO	12/600
	AD272E27A	ADATTATORE DA E27 A 2*E27	E27	BIANCO	10/250
	L800B	PORTALAMPADA E27	E27	BIANCO	---
	L800N	PORTALAMPADA E27	E27	NERO	---

**SENSORE DI MOVIMENTO a infrarossi IP20**

CE IP20

VOLT: AC220-240V - 50/60Hz
H INSTALLAZIONE: 2,2-4m (a parete)
VELCITA' DI MOVIMENTO: 0,6-1,5m/s
MATERIALE: POLICARBONATO

CODICE ARTICOLO	CONSUMO	LUCE AMBIENTALE	ØxH	DISTANZA rilevamento	ANGOLO rilevamento	CARICO MASSIMO	TEMPI	UMIDITA'	COLORE	IMBALLO
IR05a	0,5W	3/2000LUX regolabile	80x32 mm	MAX 6m <24°	360°	1.200W ⚙️	MIN 10±3s MAX 15±2min	<93% RH	BIANCO	1/50

**SENSORE DI MOVIMENTO a infrarossi IP44**

CE IP44

VOLT: AC220-240V - 50/60Hz
H INSTALLAZIONE: 1,8-2,5m (a parete)
VELCITA' DI MOVIMENTO: 0,6-1,5m/s
MATERIALE: POLICARBONATO

CODICE ARTICOLO	CONSUMO	LUCE AMBIENTALE	LxHxP	DISTANZA rilevamento	ANGOLO rilevamento	CARICO MASSIMO	TEMPI	UMIDITA'	COLORE	IMBALLO
IR09	0,5W	3/2000LUX regolabile	100x60x60 mm	MAX 12m <24°	180°	1.200W ⚙️	MIN 10±3s MAX 7±2min	<93% RH	BIANCO	1/50

**SENSORE DI MOVIMENTO a infrarossi IP44**

CE IP44

VOLT: AC220-240V - 50/60Hz
H INSTALLAZIONE: 1,8-2,5m (a parete)
VELCITA' DI MOVIMENTO: 0,6-1,5m/s
MATERIALE: POLICARBONATO

CODICE ARTICOLO	CONSUMO	LUCE AMBIENTALE	LxHxP	DISTANZA rilevamento	ANGOLO rilevamento	CARICO MASSIMO	TEMPI	UMIDITA'	COLORE	IMBALLO
IR12	0,5W	3/2000LUX regolabile	91x82x65 mm	MAX 12m <24°	180°	1.200W ⚙️	MIN 10±3s MAX 12±3min	<93% RH	BIANCO	1/50



SENSORE DI MOVIMENTO SLIM a infrarossi IP44

VOLT: AC220-240V - 50/60Hz
H INSTALLAZIONE: 1,8-2,5m (a parete)
VELCITA' DI MOVIMENTO: 0,6-1,5m/s
MATERIALE: POLICARBONATO

CE IP44

CODICE ARTICOLO	CONSUMO	LUCE AMBIENTALE	LxHxP	DISTANZA rilevamento	ANGOLO rilevamento	CARICO MASSIMO	TEMPI	UMIDITA'	COLORE	IMBALLO
IR16	0,5W	3/2000LUX regolabile	120x78x15 mm	MAX 12m <24°	180°	1.200W ⚙️	MIN 10±3s MAX 7±2min	<93% RH	BIANCO	1/50

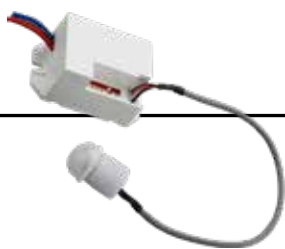

SENSORE DI MOVIMENTO da incasso a infrarossi IP20

VOLT: AC220-240V - 50/60Hz
H INSTALLAZIONE: 1,8-2,5m (a parete)
VELCITA' DI MOVIMENTO: 0,6-1,5m/s
MATERIALE: POLICARBONATO

CE IP20

CODICE ARTICOLO	CONSUMO	LUCE AMBIENTALE	DIMENSIONI	DISTANZA rilevamento	ANGOLO rilevamento	CARICO MASSIMO	TEMPI	UMIDITA'	COLORE	IMBALLO
IR24	0,5W	10/2000LUX regolabile	43x37x26mm ø 18x24	3m/6m <24°	120°/ 360°	800W ⚙️	5s/30s/1m/ 3m/5m/8m	<93% RH	BIANCO	1/100



SENSORE DI MOVIMENTO a infrarossi IP65

VOLT: AC110-277 - 50/60Hz
H INSTALLAZIONE: 4-15m
VELCITA' DI MOVIMENTO: 0,6-1,5m/s
MATERIALE: POLICARBONATO

CE IP65

CODICE ARTICOLO	CONSUMO	LUCE AMBIENTALE	DISTANZA rilevamento	ANGOLO rilevamento	CARICO MASSIMO	TEMPI	COLORE	IMBALLO
IR759A	0,9W	10/2000LUX regolabile	4-10m regolabile	360°	2000W ⚙️	5s/30s/90s/ 3m/5m/10m 20m/30m	BIANCO	1/100



SENSORE DI MOVIMENTO a infrarossi IP20

VOLT: AC220-240 - 50/60Hz
H INSTALLAZIONE: 1.5-3.5m parete | 2m-8m soffitto
VELCITA' DI MOVIMENTO: 0,6-1,5m/s
MATERIALE: POLICARBONATO



CODICE ARTICOLO	CONSUMO	LUCE AMBIENTALE	DISTANZA rilevamento	ANGOLO rilevamento	CARICO MASSIMO	TEMPI	COLORE	IMBALLO
IR701E	0,9W	3/2000LUX regolabile	5-15m parete 1-8m soffitto	360°/ 180°	1200W ⚙️	min 10s max 12m	BIANCO	1/100



MISURATORE consumi energia



CODICE ARTICOLO	VOLTAGGIO	CORRENTE	GAMMA larga estensione	ANGOLO rilevamento	CARICO MASSIMO	TEMPI	UMIDITA'	COLORE	IMBALLO
PMB-2	230V/50Hz	16mA	230V-250V	360°	1.200W ⚙️	MIN 10±3s MAX 15±2min	<93% RH	BIANCO	9/36

Intervallo di Visualizzazione

SEQUENZA DEL TEMPO: 0 secondi - 9999 giorni
ENERGIA: 0W - 9999 W (precisione ±2)
VOLTAGGIO: 0V - 9999V (precisione ±2)
CORRENTE: 0.000A - 9999A (precisione ±2)

FREQUENZA: 0Hz - 9999 Hz
PREZZO: 0.00 costo/KWh - 99.99 costo/KWh
ENERGIA: 0.000KWh - 9999 KWh
COSTO: 0.00 costo - 9999 costo

PRESA e TELECOMANDO wireless



CODICE ARTICOLO	VOLTAGGIO	ASSORBIMENTO	CODICI APPRENDIMENTO	FREQUENZA remota	DISTANZA funzionamento	COLORE	IMBALLO
RCS1	230V/50Hz	16mA/ 3680W max	>1.000.000	433.92MHz	35m	BIANCO	9/36



RCS1



CODICE ARTICOLO	VOLTAGGIO	DISTANZA funzionamento	FREQUENZA remota	BATTERIA	COLORE	IMBALLO
TLCRCS1	230V/50Hz	20m	433.92MHz	LR44* non include	BIANCO	1/1



TIMER DIGITALE



CODICE ARTICOLO	VOLTAGGIO	ASSORBIMENTO	TEMPERATURA di lavoro	PRECISIONE	BATTERIA	COLORE	IMBALLO
TM02	230V/50Hz	230V ~ AC/ 16mA/ 3680W max	-10°C +40°C	±1m ogni mese	NIMH 1.2V >100 giorni	BIANCO	9/36



TIMER 24H



CODICE ARTICOLO	VOLTAGGIO	CARICO max	TEMPO min regolazione	TEMPO max regolazione	SPINA	COLORE	IMBALLO
TIMER24H BLR	230V/50Hz	3500 W - 16A	15min	24h	16A - Presa 10/16A	BIANCO	12/48



LUCE NOTTE



CODICE ARTICOLO	WATT	VOLTAGGIO	ACCENSIONE	LUCE	COLORE	IMBALLO
LN05	0,5	220-240V / 50-60Hz	ON/OFF	ISTANTANEA	BIANCO	1/50



LAMPADE con lente da appoggio



VOLT: AC220-240V - 50/60Hz
materiale: Policarbonato + Vetro

Lente di VETRO 4" - 5 diottrie
con interruttore ON/OFF e base da tavolo

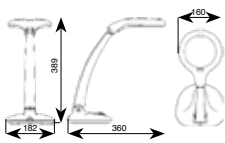

CODICE ARTICOLO	WATT	VOLT	LUMEN	KELVIN	ANGOLO	CRI	COLORE	TIPO LED	CLASSE ENERGETICA	IMBALLO
MLQ2012B	9	230	730	6500	120°	80	BIANCO	SMD		1/4
MLQ2012N	9	230	730	6500	120°	80	NERO	SMD		1/4

LAMPADE con lente con morsetto



VOLT: AC220-240V - 50/60Hz

Lente di VETRO 5" - 5 diottrie
con interruttore ON/OFF e clamp da tavolo MLQ7

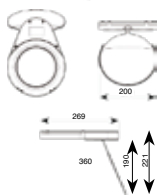

CODICE ARTICOLO	WATT	VOLT	LUMEN	KELVIN	ANGOLO	CRI	COLORE	TIPO LED	CLASSE ENERGETICA	IMBALLO
MLQ6025B	9	230	730	6500	120°	80	BIANCO	SMD		1/4
MLQ6025N	9	230	730	6500	120°	80	NERO	SMD		1/4

accessori



CODICE ARTICOLO	DESCRIZIONE	ALTEZZA	BASE	COLORE	IMBALLO
MLQ5B	PIANTANA DA PAVIMENTO CON BASE ROTONDA	62cm	Ø386X92mm	BIANCO	1
MLQ5N	PIANTANA DA PAVIMENTO CON BASE ROTONDA	62cm	Ø386X92mm	NERO	1

CODICE ARTICOLO	DESCRIZIONE	DIMENSIONI	COLORE	IMBALLO
MLQ6B	BASE DA TAVOLO	267X251X62mm	BIANCO	1
MLQ6N	BASE DA TAVOLO	267X251X62mm	NERO	1



MATASSE cavi

VOLT: AC220-240V - 50/60Hz
MAX LAMPADA LED 40W



CODICE ARTICOLO	VOLT	MATERIALE	CAVO	BOBINA	IMBALLO
PE200B	230	TESSUTO BIANCO	3X0,75	50mt	1



PE202RO	230	TESSUTO ROSSO	3X0,75	50mt	1
----------------	-----	---------------	--------	------	---



PE203BLU	230	TESSUTO BLU	3X0,75	50mt	1
-----------------	-----	-------------	--------	------	---



CODICE ARTICOLO	VOLT	MATERIALE	CAVO	BOBINA	IMBALLO
PE300ORO	230	INTRECCIATO ORO	2X0,75	50mt	1



PE301AV	230	INTRECCIATO AVORIO	2X0,75	50mt	1
----------------	-----	--------------------	--------	------	---



PE302N	230	INTRECCIATO NERO	2X0,75	50mt	1
---------------	-----	------------------	--------	------	---











PE303B	230	INTRECCIATO BIANCO	2X0,75	50mt	1
---------------	-----	--------------------	--------	------	---





PENDANT a sospensione decorativi

VOLT: AC220-240V - 50/60Hz
MAX LAMPADA LED 40W

	CODICE ARTICOLO	VOLT	ATTACCO	PORTA LAMPADA	CAVO	lunghezza CAVO	GIUNTURE	ROSETTA	IMBALLO
	PE101	230	E27	LEGNO	TESSUTO BIANCO	1500 mm	BIANCHE	BIANCO	1/10
	PE102	230	E27	LEGNO	TESSUTO NERO	1500 mm	NERE	NERO	1/10
	PE105	230	E27	METALLO ROSA	TESSUTO ROSA	1500 mm	NERE	ROSA	1/10
	PE107	230	E27	METALLO ORO	TESSUTO ORO	1500 mm	TRASPARENTI	ORO	1/10
	PE109	230	E27	SILICONE AZZURRO	TESSUTO AZZURRO	1500 mm	AZZURRE	AZZURRO	1/10
	PE110	230	E27	SILICONE BIANCO	TESSUTO BIANCO	1500 mm	BIANCHE	BIANCO	1/10
	PE111	230	E27	SILICONE VERDE	TESSUTO VERDE	1500 mm	VERDI	VERDE	1/10
	PE112	230	E27	SILICONE ROSSO	TESSUTO ROSSO	1500 mm	ROSSE	ROSSO	1/10
	PE113	230	E27	SILICONE BLU	TESSUTO BLU	1500 mm	BLU	BLU	1/10

**PLAFONIERE
A LED**



Progettati per migliorare l'efficienza e la praticità delle lampade a LED, i nostri sensori di presenza, timer e adattatori offrono flessibilità nella programmazione e nell'uso dei dispositivi LED.

I nostri accessori promuovono anche la sostenibilità, trasformando ogni ambiente in uno spazio più efficiente e accogliente.

Designed to improve the efficiency and utility of LED lamps, our presence sensors, timers and adapters offer flexibility in the programming and use of LED devices.

Our accessories also promote sustainability, transforming any room into a more efficient and welcoming space.



CABINET TONALITA' LUCE SELEZIONABILE IP20

materiale: Policarbonato



- CON INTERRUTTORE: ON/OFF
- GAP tra elementi NULLO



289 22

 N°ELEM.COLLEGABILI: 12

CODICE ARTICOLO	WATT	VOLT	LUMEN	KELVIN	ANGOLO	CRI	COLORE	TIPO LED	CLASSE ENERGETICA	IMBALLO
PROLED346-4	4	230	420	selezionabile 3K-4K-6.5K	130°	≥80	BIANCO	2*25 SMD2835	F	1/30

549 22

 N°ELEM.COLLEGABILI: 12

PROLED346-9	9	230	950	selezionabile 3K-4K-6.5K	130°	≥80	BIANCO	2*50 SMD2835	F	1/30
--------------------	---	-----	-----	--------------------------	------	-----	--------	--------------	---	------

849 22

 N°ELEM.COLLEGABILI: 12

PROLED346-13	13	230	1400	selezionabile 3K-4K-6.5K	130°	≥80	BIANCO	2*76 SMD2835	F	1/20
---------------------	----	-----	------	--------------------------	------	-----	--------	--------------	---	------

1149 22

 N°ELEM.COLLEGABILI: 12

PROLED346-18	18	230	1850	selezionabile 3K-4K-6.5K	130°	≥80	BIANCO	2*100 SMD2835	F	1/20
---------------------	----	-----	------	--------------------------	------	-----	--------	---------------	---	------

1449 22

 N°ELEM.COLLEGABILI: 12

PROLED346-22	22	230	2400	selezionabile 3K-4K-6.5K	130°	≥80	BIANCO	2*126 SMD2835	F	1/20
---------------------	----	-----	------	--------------------------	------	-----	--------	---------------	---	------

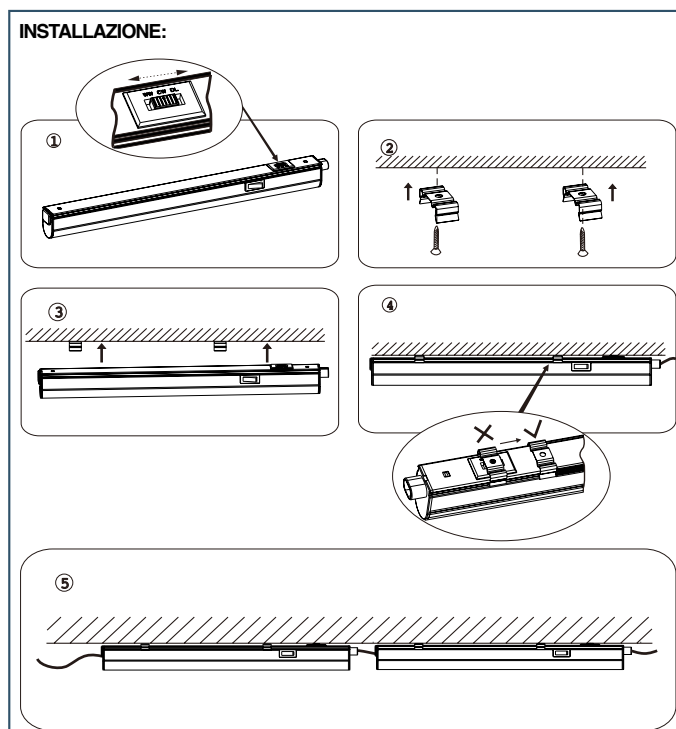



LEDDISC SMD IP20

materiale: Policarbonato

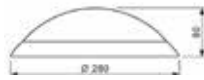

CODICE ARTICOLO	WATT	VOLT	LUMEN	KELVIN	ANGOLO	CRI	COLORE	Q.TA' LED	TIPO LED	CLASSE ENERGETICA	IMBALLO
LEDDISC3K	10	230	1100	3000	120°	≥80	BIANCA	100	SMD3014		1/10
LEDDISC4K	10	230	1100	4000	120°	≥80	BIANCA	100	SMD3014		1/10

LEDDISC SMD IP20 con SENSORE DI PRESENZA



CODICE ARTICOLO	WATT	VOLT	LUMEN	KELVIN	ANGOLO	CRI	COLORE	Q.TA' LED	TIPO LED	CLASSE ENERGETICA	IMBALLO
LEDDISC3KSENS	11	230	1100	3000	120°	≥80	BIANCA	100	SMD3014		1/10
LEDDISC4KSENS	11	230	1100	4000	120°	≥80	BIANCA	100	SMD3014		1/10

NR. MAX SCHIAVI COLLEGABILI: 30 PZ (LEDDISCSENS PUO' PILOTARE FINO A 30 LEDDISCSENS COLLEGATI IN SERIE)

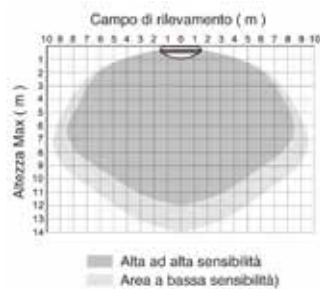

SENSORE A MICROONDE

DESCRIZIONE

- Angolo di rilevamento: 30-150°
- Campo di rilevamento: 12-18m (Diametro), regolabile
- Impostazioni del timer: 5sec-30min, regolabile
- Controllo luce: 2-50 Lux, regolabile o disabilitabile
- Max altezza: 10m



CL346 SMD TONALITA' con SELETTORE DI POTENZA con predisposizione **SENSORE DI PRESENZA**

materiale: Policarbonato + Alluminio



Ø foro
55-200 mm
230

CODICE ARTICOLO	WATT	VOLT	LUMEN	SELETTORE POTENZA	KELVIN	ANGOLO	CRI	COLORE	TIPO LED	CLASSE ENERGETICA	IMBALLO
● CL346-18SEL	18	230	1620	selezionabile 9w-12w-18w	selezionabile 3K-4K-6.5K	150°	≥80	BIANCA	SMD2835		1/20

Ø foro
55-280 mm
300

● CL346-24SEL	24	230	2160	selezionabile 12w-18w-24w	selezionabile 3K-4K-6.5K	150°	≥80	BIANCA	SMD2835		1/20
----------------------	----	-----	------	------------------------------	-----------------------------	------	-----	--------	---------	--	------

PREDISPOSIZIONE ALLOGGIO SENSORE DI PRESENZA

cod. **CLCQSENS**
(venduto separatamente)



CLCQSENS



- SISTEMA DI FISSAGGIO 2 IN 1
 - PLAFONE
 - INCASSO con molle
- ALLOGGIO SENSORE A MICROONDE:
 - cod. **CLCQSENS**
 - SELETTORE TEMPO 2s/15s/30s/60s
 - SELETTORE DISTANZA 2m/4m/8m
- SELETTORE DI POTENZA (W)
- SELETTORE TONALITA' LUCE 3K-4K-6K
- CAVO DI SICUREZZA
- SUL FIANCO E' COLLOCATO IL SENSORE DI PRESENZA



CQ346 SMD TONALITA' con SELETTORE DI POTENZA

con predisposizione **SENSORE DI PRESENZA**

materiale: Policarbonato + Alluminio



Ø foro
55-280 mm
L 300x300 mm

CODICE ARTICOLO	WATT	VOLT	LUMEN	SELETTORE POTENZA	KELVIN	ANGOLO	CRI	COLORE	TIPO LED	CLASSE ENERGETICA	IMBALLO
● CQ346-24SEL	24	230	2160	selezionabile 12w-18w-24w	selezionabile 3K-4K-6.5K	150°	≥80	BIANCA	SMD2835		1/20

PREDISPOSIZIONE ALLOGGIO SENSORE DI PRESENZA

cod. **CLCQSENS**
(venduto separatamente)



CLCQSENS

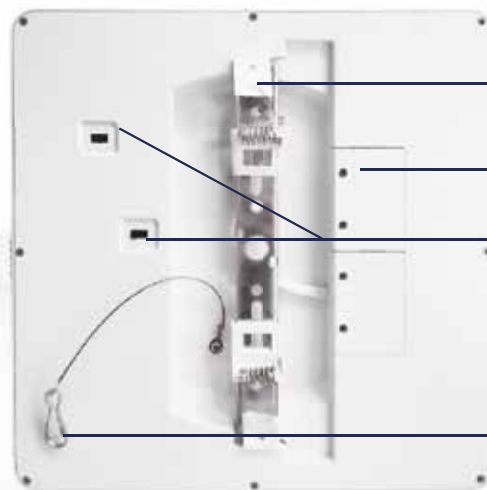

SISTEMA DI FISSAGGIO 2 IN 1
- PLAFONE
- INCASSO con molle

ALLOGGIO SENSORE A MICROONDE:
cod. **CLCQSENS**
- SELETTORE TEMPO 2s/15s/30s/60s
- SELETTORE DISTANZA 2m/4m/8m

SELETTORE DI POTENZA (W)
SELETTORE TONALITA' LUCE
3K-4K-6K

CAVO DI SICUREZZA

SUL FIANCO E' COLLOCATO IL SENSORE DI PRESENZA



CL346 SMD TONALITA' con SELETTORE DI POTENZA

materiale: Policarbonato + Alluminio



Ø foro
55-380 mm
400

CODICE ARTICOLO	WATT	VOLT	LUMEN	SELETTORE POTENZA	KELVIN	ANGOLO	CRI	COLORE	TIPO LED	CLASSE ENERGETICA	IMBALLO
• CL346-36SEL	30	230	2700	selezionabile 18w-24w-30w	selezionabile 3K-4K-6.5K	150°	≥80	BIANCA	SMD2835		1/10



**CQ346 SMD TONALITA' con SELETTORE DI POTENZA**

materiale: Policarbonato + Alluminio



Ø foro
55-380 mm
L 400x400 mm

25

CODICE ARTICOLO	WATT	VOLT	LUMEN	SELETTORE POTENZA	KELVIN	ANGOLO	CRI	COLORE	TIPO LED	CLASSE ENERGETICA	IMBALLO
● CQ346-36SEL	30	230	2700	selezionabile 18w-24w-30w	selezionabile 3K-4K-6.5K	150°	≥80	BIANCA	SMD2835	F	1/10

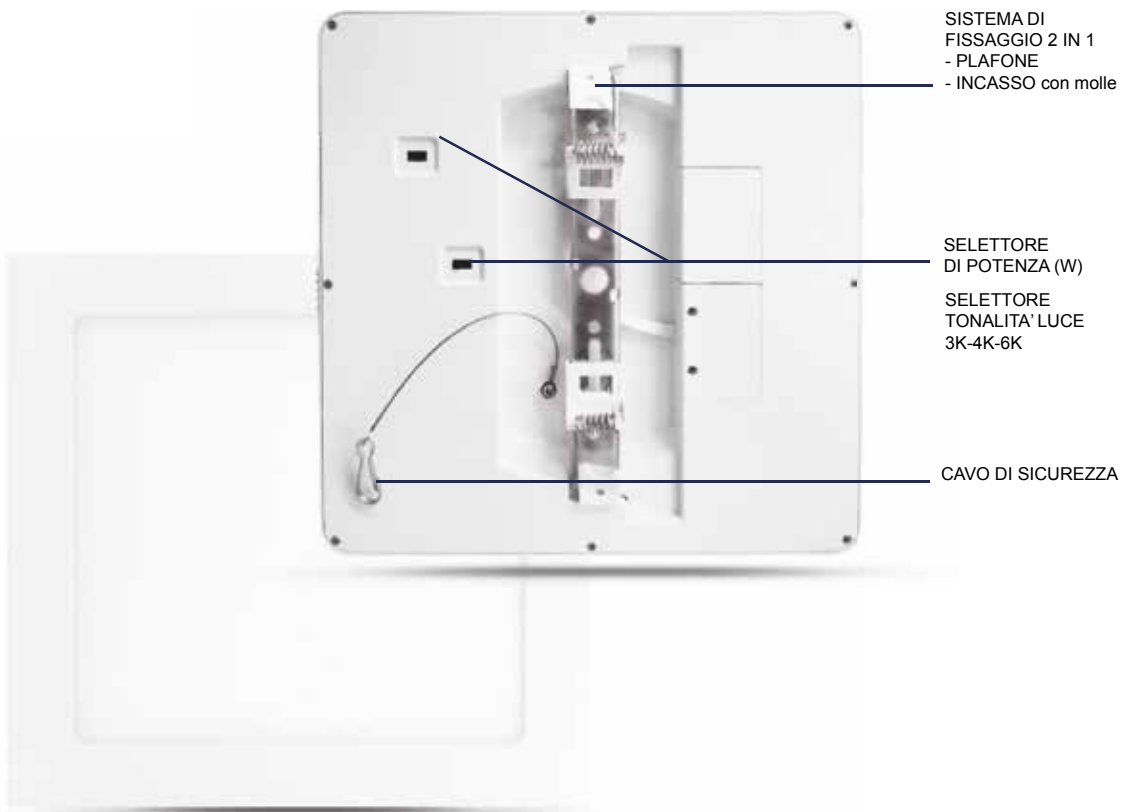



PLAFONIERE TONALITA' LUCE SELEZIONABILE IP20

materiale CORPO: Policarbonato
materiale DIFFUSORE: Policarbonato

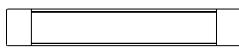

613

CODICE ARTICOLO	WATT	VOLT	LUMEN	KELVIN	ANGOLO	CRI	COLORE	DIFFUSORE	TIPO LED	CLASSE ENERGETICA	IMBALLO
PL346-24	24	230	2500	selezionabile 3K-4K-6.5K	110°	≥80	BIANCO	OPALE	2*210 SMD3528	F	1/12

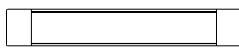

913

PL346-36	36	230	3850	selezionabile 3K-4K-6.5K	110°	≥80	BIANCO	OPALE	2*300 SMD3528	F	1/6
-----------------	----	-----	------	-----------------------------	------	-----	--------	-------	------------------	---	-----

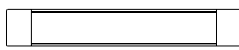

1213

PL346-48	48	230	5200	selezionabile 3K-4K-6.5K	110°	≥80	BIANCO	OPALE	2*420 SMD3528	F	1/6
-----------------	----	-----	------	-----------------------------	------	-----	--------	-------	------------------	---	-----



PLF 346 SMD TONALITA' LUCE SELEZIONABILE IP44

materiale: Policarbonato

dimensioni



	A	B
18W	80	330
24W	110	385
36W	115	490



CODICE ARTICOLO	WATT	VOLT	LUMEN	KELVIN	MISURE	ANGOLO	CRI	COLORE	TIPO LED	CLASSE ENERGETICA	IMBALLO
PLF346-18	18	230	1800	selezionabile 3K-4K-6.5K	1	120°	≥80	OPALE	SMD2835		1/5
PLF346-24	24	230	2280	selezionabile 3K-4K-6.5K	2	120°	≥80	OPALE	SMD2835		1/5
PLF346-36	36	230	3600	selezionabile 3K-4K-6.5K	3	120°	≥80	OPALE	SMD2835		1/5

PLF 346 SMD SENSORE DI PRESENZA IP44

materiale: Policarbonato

dimensioni



	A	B
1	80	330



CODICE ARTICOLO	WATT	VOLT	LUMEN	KELVIN	ANGOLO	CRI	COLORE	TIPO LED	CLASSE ENERGETICA	IMBALLO
PLF346-18-SENS	18	230	1800	selezionabile 3K-4K-6.5K	120°	≥80	OPALE	SMD2835		1/5

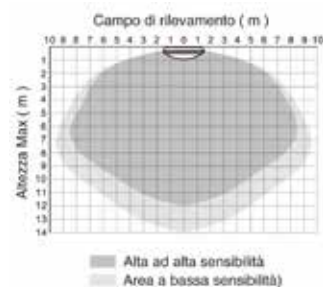

SENSORE A MICROONDE

DESCRIZIONE

- Angolo di rilevamento: 30-150°
- Campo di rilevamento: 12-18m (Diametro), regolabile
- Impostazioni del timer: 5sec-30min, regolabile
- Controllo luce: 2-50 Lux, regolabile o disabilitabile
- Max altezza: 10m



CF346 tonalità SMD TONALITA' LUCE SELEZIONABILE IP44

materiale: Policarbonato



dimensioni

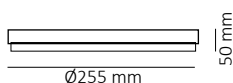

CODICE ARTICOLO	WATT	VOLT	LUMEN	KELVIN	ANGOLO	CRI	COLORE	Q.TA' LED	TIPO LED	CLASSE ENERGETICA	IMBALLO
● CF346-18	18	230	1800	selezionabile 3K-4K-6.5K	120°	≥80	BIANCA	100	SMD3014		1/10

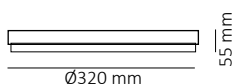

● CF346-24	24	230	2400	selezionabile 3K-4K-6.5K	120°	≥80	BIANCA	100	SMD3014		1/10
-------------------	----	-----	------	-----------------------------	------	-----	--------	-----	---------	--	------

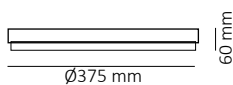

● CF346-36	36	230	3600	selezionabile 3K-4K-6.5K	120°	≥80	BIANCA	100	SMD3014		1/2
-------------------	----	-----	------	-----------------------------	------	-----	--------	-----	---------	--	-----

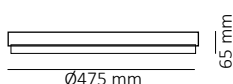

● CF346-48	48	230	4800	selezionabile 3K-4K-6.5K	120°	≥80	BIANCA	100	SMD3014		1/1
-------------------	----	-----	------	-----------------------------	------	-----	--------	-----	---------	--	-----

CF346 tonalità luce selezionabile SMD IP44 con SENSORE DI PRESENZA

materiale: Policarbonato



dimensioni

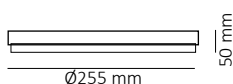

CODICE ARTICOLO	WATT	VOLT	LUMEN	KELVIN	ANGOLO	CRI	COLORE	Q.TA' LED	TIPO LED	CLASSE ENERGETICA	IMBALLO
● CF346-18SENS	18	230	1800	selezionabile 3K-4K-6.5K	120°	≥80	BIANCA	100	SMD3014		1/10

**RONDO346 SMD TONALITA' LUCE SELEZIONABILE IP54**

materiale: Policarbonato

colore COVER a scelta



CODICE ARTICOLO	ARTICOLO	MATERIALE	COLORE	IMBALLO
RONDORINGB	COVER	ABS	BIANCO	1
RONDORINGG	COVER	ABS	GRIGIO	1
RONDORINGN	COVER	ABS	NERO	1

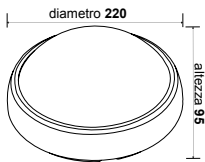

CODICE ARTICOLO	WATT	VOLT	LUMEN	KELVIN	ANGOLO	CRI	COLORE	TIPO LED	CLASSE ENERGETICA	IMBALLO
RONDO346	13	230	1000	selezionabile 3K-4K-6.5K	180°	≥80	OPALE	SMD2835		1/12

**ELLISSE346 SMD TONALITA' LUCE SELEZIONABILE IP54**

materiale: Policarbonato

colore COVER a scelta



CODICE ARTICOLO	ARTICOLO	MATERIALE	COLORE	IMBALLO
ELLISSERINGB	COVER	ABS	BIANCO	1
ELLISSERINGG	COVER	ABS	GRIGIO	1
ELLISSERINGN	COVER	ABS	NERO	1

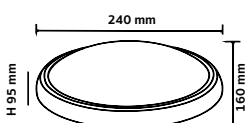

CODICE ARTICOLO	WATT	VOLT	LUMEN	KELVIN	ANGOLO	CRI	COLORE	TIPO LED	CLASSE ENERGETICA	IMBALLO
ELLISSE346	13	230	1000	selezionabile 3K-4K-6.5K	180°	≥80	OPALE	SMD2835		1/12



PLF 22 SMD IP65

materiale: Policarbonato

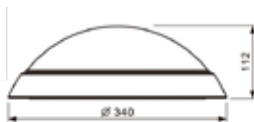

CODICE ARTICOLO	WATT	VOLT	LUMEN	KELVIN	ANGOLO	CRI	COLORE	Q.TA' LED	TIPO LED	CLASSE ENERGETICA	IMBALLO
PLF22LED3K	22	230	1800	3000	120°	≥80	BIANCO	200	SMD3014		1/5
PLF22LED4K	22	230	1800	4000	120°	≥80	BIANCO	200	SMD3014		1/5



PLF 22 SMD IP65 con SENSORE DI PRESENZA

materiale: Policarbonato

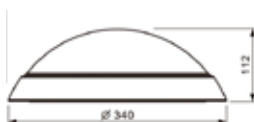

CODICE ARTICOLO	WATT	VOLT	LUMEN	KELVIN	ANGOLO	CRI	COLORE	Q.TA' LED	TIPO LED	CLASSE ENERGETICA	IMBALLO
PLF22SENS3K	22	230	1800	3000	120°	≥80	BIANCO	200	SMD3014		1/5
PLF22SENS4K	22	230	1800	4000	120°	≥80	BIANCO	200	SMD3014		1/5

NR. MAX SCHIAVI COLLEGABILI: 15 PZ (PLF22SENS PUO' PILOTARE FINO A 15 PLF22 COLLEGATI IN SERIE)



PLAFONIERE SMD IP65 TONALITA' LUCE SELEZIONABILE DIMMERABILE

materiale CORPO: Policarbonato
materiale DIFFUSORE: Policarbonato

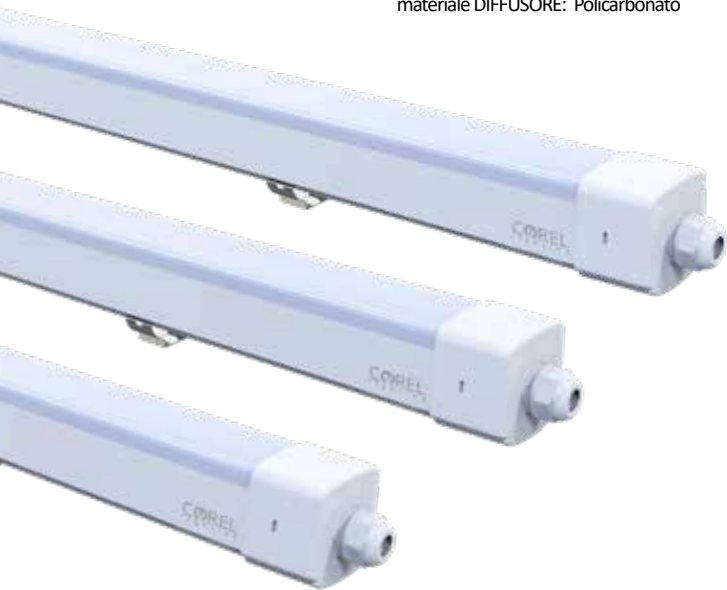

ELEMENTO DI CONNESSIONE



CABLAGGIO IP65 SU ENTRAMBI I LATI

LIFE TIME
30.000 h

IP65

CLASSE
II

IK08

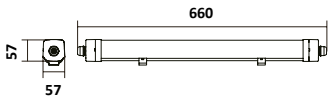

CODICE ARTICOLO	WATT	VOLT	LUMEN	KELVIN	ANGOLO	CRI	COLORE	DIFFUSORE	Q.TA' LED	CLASSE ENERGETICA	IMBALLO
PL2010LED	SELETTORE POTENZA		1300 lm 2600 lm	3000K 4000K 5700K	120°	>80	BIANCO	OPALE	156 SMD	E	1/12
	10W	230									
	20W										

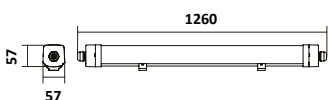

PL4020LED	SELETTORE POTENZA		2600 lm 5200 lm	3000K 4000K 5700K	120°	>80	BIANCO	OPALE	312 SMD	E	1/9
	20W	230									
	40W										

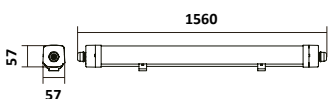

PL5025LED	SELETTORE POTENZA		3250 lm 6500 lm	3000K 4000K 5700K	120°	>80	BIANCO	OPALE	396 SMD	E	1/9
	25W	230									
	50W										



PLAFONIERA policarbonato IP65

materiale BASE alloggiamento led: alluminio
 materiale CORPO: policarbonato
 materiale DIFFUSORE: policarbonato

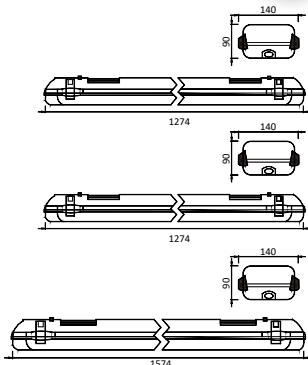

CODICE ARTICOLO	WATT	VOLT	FLUSSO LUMINOSO sorgente	FLUSSO LUMINOSO in uscita	KELVIN	ANGOLO	CRI	DIFFUSORE	TIPO LED	CLASSE ENERGETICA	IMBALLO
● PL25LED	25	230	---	3000	4000	120°	≥80	OPALE	SMD 2835		1/9
PL53LEDM	53	230	7000	6500	4000	120°	≥80	OPALE	SMD 2835		1/6
PL65LEDM	65	230	8600	8000	4000	120°	≥80	OPALE	SMD 2835		1/6



Moduli LED sostituibili

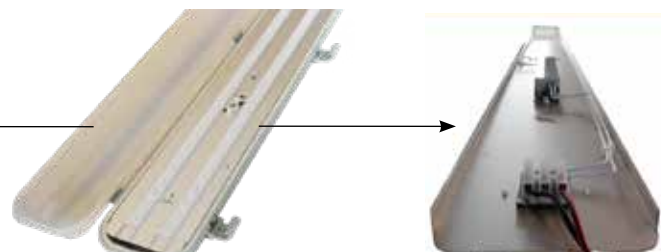

BASE in metallo

PARTI DI RICAMBIO



CODICE ARTICOLO	DESCRIZIONE
PR022	DRIVER DI RICAMBIO PER PL53LEDM/PL25LED
PR023	DRIVER DI RICAMBIO PER PL65LEDM

KIT emergenza UNIVERSALE



CODICE ARTICOLO	TENSIONE D'INGRESSO	TENSIONE D'USCITA/POTENZA (emergency mode)	BATTERIA	DURATA EM MODE	DIMENSIONI	IMBALLO
KITEMPL5365	220/240V - 50/60Hz	50-300 V Dc 2W CP	LiFePO4 3.2V 1.6Ah	180 min.	160X30Xh23	1

*CP: constant power

CORRENTE D'INGRESSO	10-60mA
POTENZA D'USCITA	4W
POWER FACTOR	>0.6
CORRENTE MASSIMA IN INGRESSO	AC 3A Max
RANGE VOLTAGGIO IN USCITA	DC50-300V 10-50V Dc
CORRENTE MASSIMA IN USCITA	600mA
POTENZA MASSIMA (costante)	6W MAX
CORRENTE PER RICARICA	300mA
TEMPO DI RICARICA	24H
TENSIONE ALTERNATA AC DRIVER	DC60V 3A Max
LUMINOSITA'	140lm/W
TEMPERATURA MAX UTILIZZO	70°C

CODICE ARTICOLO	DESCRIZIONE
PR046	DRIVER DI RICAMBIO PER PAL36LENS
PR047	DRIVER DI RICAMBIO PER PAL45LENS
PR048	DRIVER DI RICAMBIO PER PAL45CCT-DIMM



PLAFONIERE standard IP65

materiale CORPO: policarbonato
 materiale DIFFUSORE: policarbonato
 materiale GANCI: metallo

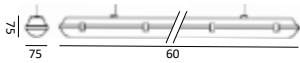

CODICE ARTICOLO	WATT	VOLT	LUMEN	KELVIN	ANGOLO	CRI	COLORE	DIFFUSORE	TIPO LED	IMBALLO
● PL184K	18	230	2100	4000	100°	≥80	RAL7035	OPALE	51* SMD2835	1/12

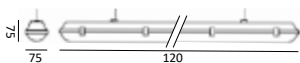

CODICE ARTICOLO	WATT	VOLT	LUMEN	KELVIN	ANGOLO	CRI	COLORE	DIFFUSORE	TIPO LED	IMBALLO
PL364K	36	230	4300	4000	100°	≥80	RAL7035	OPALE	96* SMD2835	1/12
PL366K	36	230	4300	6000	100°	≥80	RAL7035	OPALE	96* SMD2835	1/12

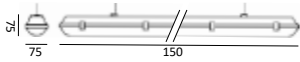

CODICE ARTICOLO	WATT	VOLT	LUMEN	KELVIN	ANGOLO	CRI	COLORE	DIFFUSORE	TIPO LED	IMBALLO
PL504K	50	230	6000	4000	100°	≥80	RAL7035	OPALE	96* SMD2835	1/9
PL506K	50	230	6000	6000	100°	≥80	RAL7035	OPALE	96* SMD2835	1/9

PARTI DI RICAMBIO

CODICE ARTICOLO	DESCRIZIONE
PR062	DRIVER DI RICAMBIO PER PL184K
PR020	DRIVER DI RICAMBIO PER PL364K - PL366K
PR021	DRIVER DI RICAMBIO PER PL504K - PL506K



PLAFONIERA vuota SINGOLA per tubi a LED IP65

VOLT: 230V - 50/60Hz
220V da un lato solo

MONTAGGIO:

A SOFFITTO O A SOSPENSIONE
(GANCIO A TRIANGOLO INCLUSO)

CE IP65 IK08

CODICE ARTICOLO	VOLT	N.CLIPS	LxPxH mm	TUBI LED	ATTACCO	CAVO	INGRESSO	DIFFUSORE	IMBALLO
CO118	230	6	660x75x82	600 mm (1x18W)	G13	0,5mm incluso	pressacavo	CLEAR	1/25
CO136	230	10	1260x75x82	1200 mm (1x36W)	G13	0,5mm incluso	pressacavo	CLEAR	1/16
CO158	230	12	1560x75x82	1500 mm (1x58W)	G13	0,5mm incluso	pressacavo	CLEAR	1/12

materiale CORPO: Policarbonato
materiale DIFFUSORE: Policarbonato



PLAFONIERA vuota DOPPIA per tubi a LED IP65

VOLT: 230V - 50/60Hz
220V da un lato solo

MONTAGGIO:

A SOFFITTO O A SOSPENSIONE
(GANCIO A TRIANGOLO INCLUSO)

CE IP65 IK08

CODICE ARTICOLO	VOLT	N.CLIPS	LxPxH mm	TUBI LED	ATTACCO	CAVO	INGRESSO	DIFFUSORE	IMBALLO
CO218	230	6	660x75x82	600 mm (2x18W)	G13	0,5mm incluso	pressacavo	CLEAR	1/20
CO236	230	10	1260x75x82	1200 mm (2x36W)	G13	0,5mm incluso	pressacavo	CLEAR	1/10
CO258	230	12	1560x75x82	1500 mm (2x58W)	G13	0,5mm incluso	pressacavo	CLEAR	1/8



TUBO LED tonalità luce selezionabile

VOLT: 175-265V - 50/60Hz
ALIMENTAZIONE DA UN LATO SOLO
SHUNT incluso

materiale: Nano Plastica



CODICE ARTICOLO	WATT	BASE	VOLT	LUMEN	KELVIN	CRI	ANGOLO	LxØ mm	TIPO LED	CLASSE ENERGETICA	IMBALLO
T8LED346-9	9	G13	175-265	900	selezionabile 3-4-6.5K	>90	180°	600x28	SMD	F	1/25
T8LED346-18	18	G13	175-265	1800	selezionabile 3-4-6.5K	>90	180°	1200x28	SMD	F	1/30
T8LED346-22	22	G13	175-265	2200	selezionabile 3-4-6.5K	>90	180°	1500x28	SMD	F	1/30

TUBO LED standard

VOLT: 230V - 50/60Hz
ALIMENTAZIONE DA UN LATO SOLO
SHUNT incluso



CODICE ARTICOLO	WATT	BASE	VOLT	LUMEN	KELVIN	MATERIALE	CRI	ANGOLO	LxØ mm	CLASSE ENERGETICA	IMBALLO
LD0942	9	G13	230	760	4000	PC+AL	>80	180°	600x26	G	1/25
LT94NM	9	G13	230	900	4000	PC+AL	>80	180°	600x26	G	1/25
4161001321	9	G13	230	920	4000	VETRO	>80	180°	600x28	F	1/25
4161001421	9	G13	230	920	6500	VETRO	>80	180°	600x28	F	1/25
4211000321	16	G13	230	2250	4000	VETRO	>80	230°	1200x28	D	1/25
4211000421	16	G13	230	2250	6500	VETRO	>80	230°	1200x28	D	1/25
LD1842	18	G13	230	1500	4000	PC+AL	>80	180°	1200x26	G	1/25
4211000521	22	G13	230	2750	4000	VETRO	>80	230°	1500x28	E	1/25
4211000621	22	G13	230	2750	6500	VETRO	>80	230°	1500x28	E	1/25
LD2742	27	G13	230	2300	4000	PC+AL	>80	180°	1500x26	F	1/25

**SISTEMA LINEARE
A LED**



Il nostro sistema lineare modulare EASYLINK è progettato per garantire massima flessibilità e adattabilità nella progettazione di ambienti interni e arredo su misura. Grazie alla sua innovativa struttura con base in alluminio e snodi flessibili, offre una luce continua senza ombre, seguendo le forme e le esigenze specifiche del tuo progetto.

Our EASYLINK modular linear system is designed to ensure maximum flexibility and adaptability when it comes to interior design and custom furniture.

Thanks to its innovative structure with aluminum base and flexible joints, it offers continuous light without shadows, following the specific shapes and requirements of your project.



EASYLINK



sistema modulare IP20
DIMMERABILE
 tonalita luce **SELEZIONABILE**



DISPLAY

espositore prodotto

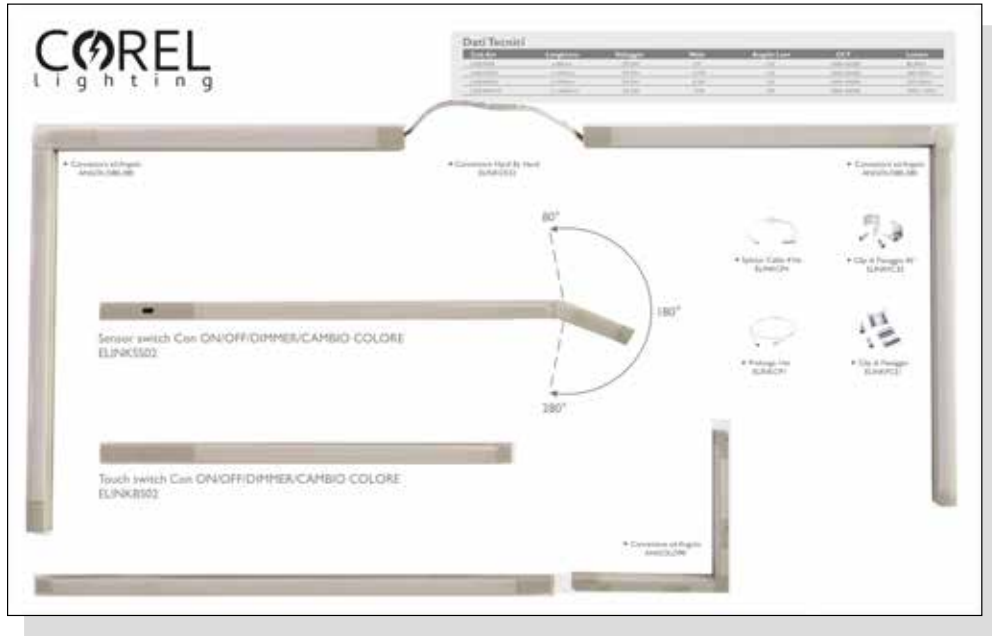

CODICE ARTICOLO	LUNGHEZZA	ALTEZZA	PROFONDITA'	IMBALLO
ELINKDISPLAY	80cm	50cm	5cm	1





COMPONENTI

sistema modulare **DIMMERABILE - TONALITA' LUCE SELEZIONABILE**

- CON INTERRUTTORE: ON/OFF
- GAP di luce tra elementi Nullo

materiale: Alluminio + Policarbonato



CODICE ARTICOLO	WATT	VOLT	LUMEN	KELVIN	ANGOLO	CRI	COLORE	DIFFUSORE	TIPO LED	CLASSE ENERGETICA	IMBALLO
ANGOLO90 GIUNTO A 90°	1	DC 24V	75/80	selezionabile 3K-4K-6K	120°	≥80	ALLUMINIO	OPALE	SMD2835		1/150

dimensioni: H12xP16xL84mm



ANGOLO80-280 GIUNTO DA 80° a 280°	1	DC 24V	75/80	selezionabile 3K-4K-6K	120°	≥80	ALLUMINIO	OPALE	SMD2835		1/80
---	---	--------	-------	---------------------------	------	-----	-----------	-------	---------	--	------

dimensioni: H12xP16xL84mm



LINEARE8 modulo LINEARE DA 84mm	1	DC 24V	75/80	selezionabile 3K-4K-6K	120°	≥80	ALLUMINIO	OPALE	SMD2835		1/80
---	---	--------	-------	---------------------------	------	-----	-----------	-------	---------	--	------

dimensioni: H12xP16xL84mm



LINEARE26 modulo LINEARE DA 260mm	3.5	DC 24V	260/280	selezionabile 3K-4K-6K	120°	≥80	ALLUMINIO	OPALE	SMD2835		1/80
---	-----	--------	---------	---------------------------	------	-----	-----------	-------	---------	--	------

dimensioni: H12xP16xL260mm



LINEARE50 modulo LINEARE DA 500mm	7	DC 24V	520/560	selezionabile 3K-4K-6K	120°	≥80	ALLUMINIO	OPALE	SMD2835		1/80
---	---	--------	---------	---------------------------	------	-----	-----------	-------	---------	--	------

dimensioni: H12xP16xL500mm



LINEARE100 modulo LINEARE DA 1000mm	14	DC 24V	1100/1200	selezionabile 3K-4K-6K	120°	≥80	ALLUMINIO	OPALE	SMD2835		1/40
---	----	--------	-----------	---------------------------	------	-----	-----------	-------	---------	--	------

dimensioni: H12xP16xL1000mm

CODICE ARTICOLO	VOLT	LUNGHEZZA	MATERIALE	TEST REISTENCA CALORE	IMBALLO
ELINKCE32 CONNETTORE HAND BY HAND	300V	0,5m	PC	70°	1
ELINKCC32 CAVO INPUT POWER LINE	300V	0,5m	PC	70°	1



CODICE ARTICOLO	VOLT	LUNGHEZZA	MATERIALE	TEST REISTENCA CALORE	IMBALLO
ELINKCP1 CAVO PROLUNGA 1m	300V	1m	PC	70°	1
ELINKCP4 SPLITTER CABLE 4 VIE 0,5m	300V	0,5m	PC	70°	1



CODICE ARTICOLO	LUNGHEZZA	MATERIALE	IMBALLO
ELINKBS02 CAVO TOUCH SWITCH CON ON/OFF/DIMMER/CAMBIO COLORE	0,5m	Al+PC	1
ELINKSS02 CAVO SENSOR SWITCH CON ON/OFF/DIMMER/CAMBIO COLORE	0,5m	Al+PC	1



CODICE ARTICOLO	MATERIALE	IMBALLO
ELINKFC31 CLIP FISSAGGIO PIATTE	Al	1
ELINKFC32 CLIP FISSAGGIO 45°	Al	1
ELINKFC33 CLIP MAGNETICHE	Al	1



**FARETTI ESTERNI E DA INCASSO
A LED**



I nostri faretti offrono un'illuminazione versatile ed elegante. Grazie al design moderno e alle diverse opzioni di montaggio, possono essere utilizzati in molteplici modi. Inoltre, puoi scegliere tra varie finiture e potenze per personalizzare al massimo i tuoi spazi interni ed esterni.

Our spotlights offer a flexible and stylish lighting. With modern designs and a variety of mounting options, they can be used in multiple ways. Plus, you can choose from a variety of finishes and wattages to maximize the customization of your indoor and outdoor spaces.



FARETTI da incasso SMD TONALITA' LUCE SELEZIONABILE

materiale: Policarbonato

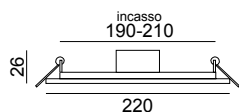
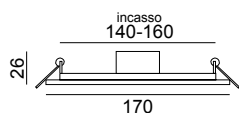

CODICE ARTICOLO	WATT	VOLT	LUMEN	KELVIN	ANGOLO	CRI	COLORE	Ø FORO INCASSO	TIPO LED	CLASSE ENERGETICA	IMBALLO
ROUND222CCT	18	230	1900	selezionabile 3K-4K-6.5K	110°	≥80	BIANCO	140-160 mm	2835	E	1/20

ROUND300CCT	24	230	2600	selezionabile 3K-4K-6.5K	110°	≥80	BIANCO	190-210 mm	2835	E	1/20
--------------------	----	-----	------	--------------------------	------	-----	--------	------------	------	---	------

accessori

CODICE ARTICOLO	DESCRIZIONE
FRAME-R222	CORNICE PER ROUND 222CCT - PER IL MONTAGGIO A PLAFONE - COLORE BIANCO - DIM. Ø170X36MM
FRAME-R300	CORNICE PER ROUND 222CCT - PER IL MONTAGGIO A PLAFONE - COLORE BIANCO - DIM. Ø220X36MM



FARETTI da incasso SMD TONALITA' LUCE SELEZIONABILE

materiale: Policarbonato

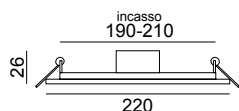
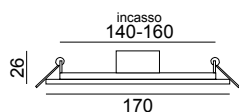

CODICE ARTICOLO	WATT	VOLT	LUMEN	KELVIN	ANGOLO	CRI	COLORE	Ø FORO INCASSO	TIPO LED	CLASSE ENERGETICA	IMBALLO
SQUARE222CCT	18	230	1900	selezionabile 3K-4K-6.5K	110°	≥80	BIANCO	140-160 mm	2835	E	1/20

SQUARE300CCT	24	230	2600	selezionabile 3K-4K-6.5K	110°	≥80	BIANCO	190-210 mm	2835	E	1/20
---------------------	----	-----	------	--------------------------	------	-----	--------	------------	------	---	------

accessori

CODICE ARTICOLO	DESCRIZIONE
FRAME-S222	CORNICE PER SQUARE222CCT - PER IL MONTAGGIO A PLAFONE - COLORE BIANCO - DIM. 170X36MM



CODICE ARTICOLO	DESCRIZIONE
PR038	DRIVER DI RICAMBIO PER ROUND222CCT/SQUARE222CCT
PR039	DRIVER DI RICAMBIO PER ROUND300CCT/SQUARE300CCT

PARTI DI RICAMBIO



FARETTI da incasso TONALITA'

luce selezionabile e DIMMERABILE



materiale: Alluminio + Policarbonato

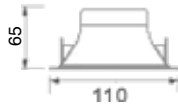

CODICE ARTICOLO	WATT	VOLT	LUMEN	KELVIN	ANGOLO	CRI	COLORE	Ø FORO	TIPO LED	CLASSE ENERGETICA	IMBALLO
DL346-D	9	230	700	selezionabile 3K-4K-6.5K	100°	≥80	BIANCO	92	2835	G	1/20

cover BIANCA inclusa



CODICE ARTICOLO	ARTICOLO	MATERIALE	COLORE	IMBALLO
RING346S	COVER	ABS	ARGENTO	1
RING346N	COVER	ABS	NERO	1
RING346G	COVER	ABS	ORO	1



FARETTI da incasso TONALITA'

luce selezionabile e DIMMERABILE

materiale: Alluminio + Policarbonato

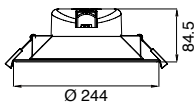
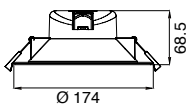

CODICE ARTICOLO	WATT	VOLT	LUMEN	KELVIN	ANGOLO	CRI	COLORE	Ø FORO	TIPO LED	CLASSE ENERGETICA	IMBALLO
DL346-D18W	18	230	1800	selezionabile 3K-4K-6.5K	100°	≥80	BIANCO	140	SMD 2835	F	1/10
DL346-D25W	25	230	2500	selezionabile 3K-4K-6.5K	100°	≥80	BIANCO	195	SMD 2835	F	1/10

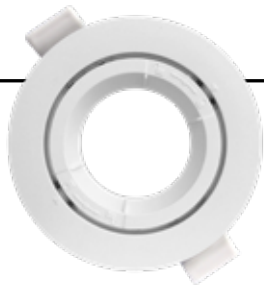

FARETTI da incasso con attacco **GU10**

materiale: Policarbonato

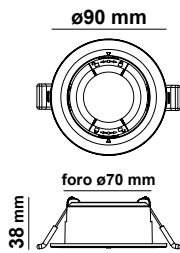

CODICE ARTICOLO	ATTACCO	LAMPADINA	COLORE	Ø FORO	IMBALLO
DLB	GU10 IN DOTAZIONE	NON INCLUSA	BIANCO	70	1/100

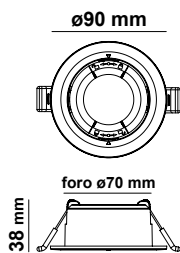

CODICE ARTICOLO	ATTACCO	LAMPADINA	COLORE	Ø FORO	IMBALLO
DLN	GU10 IN DOTAZIONE	NON INCLUSA	NERO	70	1/100



FARETTI da incasso SMD IP40

materiale: lega di Alluminio



CODICE ARTICOLO	WATT	VOLT	LUMEN	KELVIN	ANGOLO	CRI	COLORE	Ø FORO	TIPO LED	CLASSE ENERGETICA	IMBALLO
DL190184K	18	230	1500	4000	120°	≥80	BIANCO	160	SMD2835		1/10



FARETTI da incasso COB IP40

materiale: lega di Alluminio

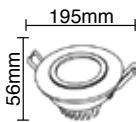

CODICE ARTICOLO	WATT	VOLT	LUMEN	KELVIN	ANGOLO	CRI	COLORE	Ø FORO	TIPO LED	CLASSE ENERGETICA	IMBALLO
DL195204K	20	230	1800	4000	120°	≥80	OPALE	170	COB		1/10



FARETTO ultraslim LED IP65

VOLT: AC220-240V - 50/60Hz

materiale: Alluminio + Policarbonato + Vetro Prismatico temperato

CAVO ALIMENTAZIONE 0,30 MT

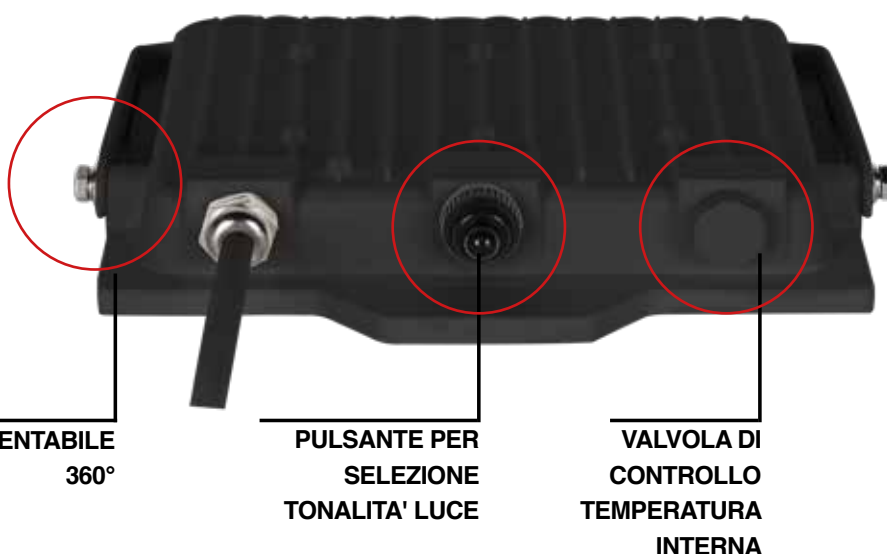

STAFFA ORIENTABILE
360°

PULSANTE PER
SELEZIONE
TONALITA' LUCE

VALVOLA DI
CONTROLLO
TEMPERATURA
INTERNA

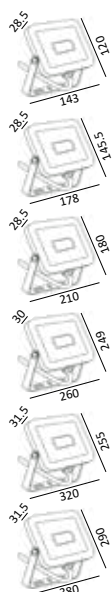

CODICE ARTICOLO	WATT	VOLT	LUMEN	KELVIN	ANGOLO	CRI	COLORE	TIPO LED	CLASSE ENERGETICA	IMBALLO
● FL346-30	30	230	3350	3CCT 3000K 4000K 6500K	110°	80	NERO	SMD 2835		1/20
● FL346-50	50	230	5700	3CCT 3000K 4000K 6500K	110°	80	NERO	SMD 2835		1/20
● FL346-70	70	230	8500	3CCT 3000K 4000K 6500K	110°	80	NERO	SMD 2835		1/20
● FL346-100	100	230	11500	3CCT 3000K 4000K 6500K	110°	80	NERO	SMD 2835		1/10
● FL346-150	150	230	17000	3CCT 3000K 4000K 6500K	110°	80	NERO	SMD 2835		1/5
● FL346-200	200	230	22500	3CCT 3000K 4000K 6500K	110°	80	NERO	SMD 2835		1/5

**FARETTO** ultraslim LED IP65

VOLT: AC220-240V - 50/60Hz

materiale: Alluminio + Policarbonato + Vetro Prismatico temperato

CAVO ALIMENTAZIONE 0,30 MT

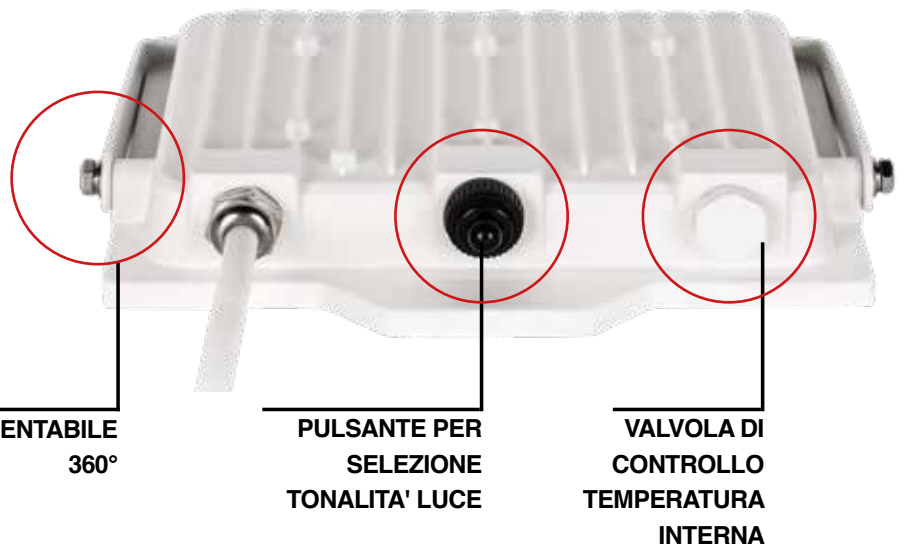
**STAFFA ORIENTABILE**
360°**PULSANTE PER**
SELEZIONE
TONALITA' LUCE**VALVOLA DI**
CONTROLLO
TEMPERATURA
INTERNA

CODICE ARTICOLO	WATT	VOLT	LUMEN	KELVIN	ANGOLO	CRI	COLORE	TIPO LED	CLASSE ENERGETICA	IMBALLO
● FL346-30	30	230	3350	3CCT 3000K 4000K 6500K	110°	80	BIANCO	SMD 2835		1/20
● FL346-50	50	230	5700	3CCT 3000K 4000K 6500K	110°	80	BIANCO	SMD 2835		1/20
● FL346-100	100	230	11500	3CCT 3000K 4000K 6500K	110°	80	BIANCO	SMD 2835		1/20



FARETTO con predisposizione al **SENSORE** ultraslim LED **IP65**

VOLT: AC220-240V - 50/60Hz

materiale: Alluminio + Policarbonato + Vetro Prismatico temperato

CAVO ALIMENTAZIONE 0,30 MT



cod. art. **FLSENS**

Sensore di presenza
PLUG-IN

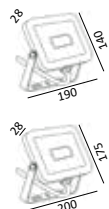

CODICE ARTICOLO	WATT	VOLT	LUMEN	KELVIN	ANGOLO	CRI	COLORE	TIPO LED	CLASSE ENERGETICA	IMBALLO
● FL304K-SENS	30	230	3350	4000K	110°	80	NERO	SMD 2835		1/20
● FL504K-SENS	50	230	5700	4000K	110°	80	NERO	SMD 2835		1/20



FARO SOLARE

ultraslim LED IP65



Pannello SOLARE
ad ALTA EFFICIENZA



PANNELLO LED ORIENTABILE fissaggio con STAFFA



Dati tecnici

Accensione ON/OFF click 5sec
Luminosità 100%-60%-30% click breve
Materiale **ABS+VETRO**
Angolo rilevamento **120°**
Distanza rilevamento **4m MAX**
Altezza installazione **1,8-2,5m**
Batteria Litio **3.7V 2600mAh SOSTITUIBILE**
Sensore crepuscolare **<10 lux**
Temperatura di lavoro **-10 +55° C**

LIFE TIME
30.000 h

IP65

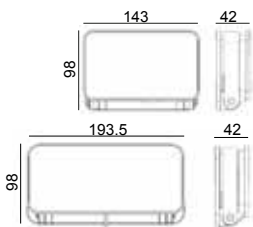

CODICE ARTICOLO	WATT	LUMEN	KELVIN	ANGOLO RILEVAMENTO	SENSORE CREPUSCOLARE	COLORE	TIPO LED	IMBALLO
● FLSOLAR-10	10	SELEZIONABILE	3CCT	120°	<10 lux	NERO	40*SMD 2835	1/20
		100% - 1000lm 60% - 600lm 30% - 300lm	3000K 4000K 6500K					
● FLSOLAR-20	20	SELEZIONABILE	3CCT	120°	<10 lux	NERO	48*SMD 2835	1/20
		100% - 1300lm 60% - 700lm 30% - 350lm	3000K 4000K 6500K					



FARETTO ultraslim LED IP65

VOLT: AC100-240V - 50/60Hz
 materiale: Alluminio + Vetro



CODICE ARTICOLO	WATT	VOLT	LUMEN	KELVIN	ANGOLO	CRI	COLORE	TIPO LED	CLASSE ENERGETICA	IMBALLO
SFL10W-WW-B	10	230	630	3000	>100°	70	BIANCO	SMD		1/20
SFL10W-CW-B	10	230	630	4000	>100°	70	BIANCO	SMD		1/20
SFL20W-WW-B	20	230	1400	3000	>100°	70	BIANCO	SMD		1/12
SFL30W-CW-N	30	230	2100	4000	>100°	70	NERO	SMD		1/8
SFL50W-CW-B	50	230	3500	4000	>100°	70	BIANCO	SMD		1/5



FARETTO ultraslim LED

VOLT: AC100-240V - 50/60Hz
 materiale: Alluminio + Vetro

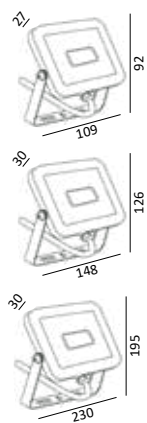

CODICE ARTICOLO	WATT	VOLT	LUMEN	KELVIN	ANGOLO	CRI	COLORE	TIPO LED	CLASSE ENERGETICA	IMBALLO
PR10-4K	10	230	800	4000	110°	70	BIANCO	SMD		1/60
PR20-4K	20	230	1600	4000	110°	70	BIANCO	SMD		1/30
PR50-4K	50	230	4500	4000	120°	70	BIANCO	SMD		1/20



FARETTO alta prestazione LED

VOLT: AC100-240V - 50/60Hz
materiale: Alluminio

EFFICIENZA LUMINOSA LED: 80Lm/W
EFFICIENZA LAMPADA: $\geq 90\%$

con SENSORE CREPUSCOLARE

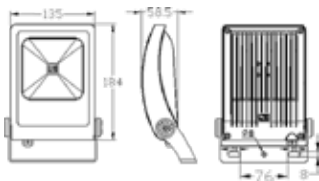

CODICE ARTICOLO	WATT	VOLT	LUMEN	KELVIN	ANGOLO	CRI	COLORE	TIPO LED	CLASSE ENERGETICA	IMBALLO
FG14615PTC	15	230	1200	4000	100°	75	GRIGIO	SMD		1/10

con SENSORE DI PRESENZA

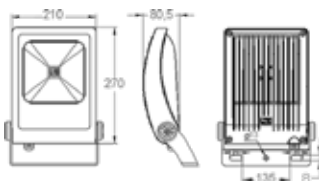

CODICE ARTICOLO	WATT	VOLT	LUMEN	KELVIN	ANGOLO	CRI	COLORE	TIPO LED	CLASSE ENERGETICA	IMBALLO
FG14615SENSO	15	230	1200	4000	100°	75	GRIGIO	SMD		1/10
										dim. 184x135z58.5 mm
FG22230SENSO	30	230	2400	4000	100°	75	GRIGIO	SMD		1/4
										dim. 270x210z80.5 mm

SUPPORTO A MURO



CODICE ARTICOLO	CARATTERISTICHE	LUNGHEZZA	COMPATIBILE CON	COLORE	IMBALLO
LH300	SUPPORTO A MURO con PIASTRA DI MONTAGGIO	310 mm	FARO FG146/FG222	GRIGIO	1



FARO ricaricabile DIMMERABILE 10W - IP65

materiale: Alluminio + Vetro

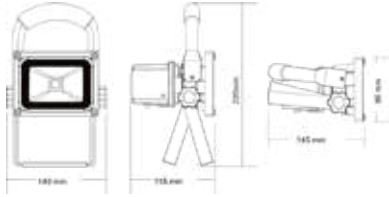

CODICE ARTICOLO	WATT	LUMEN	KELVIN	ANGOLO	CRI	COLORE	TIPO LED	CLASSE ENERGETICA	IMBALLO
LR10	10	800	5500	120°	≥70	NERO	EPISTAN		1/16

accessori inclusi nella confezione



VOLT: AC 100-240V / DC 12-24V / 50-60Hz

FUNZIONAMENTO COSTANTE: CORRENTE COSTANTE

PROTEZIONE: SOVRACCARICHI E SCARICHI

BATTERIA: RICARICABILE AL LITIO 7.4V, 4.400mA

TEMPO RICARICA: 5h

TEMPO LAVORO: 3-4h

ACCESSORI INCLUSI: BORSA A TRACCOLLA PROTETTIVA



FARO TASCABILE ricaricabile COB

materiale: Alluminio

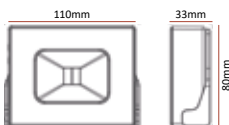

CODICE ARTICOLO	WATT	VOLT	LUMEN	KELVIN	ANGOLO	CRI	COLORE	TIPO LED	CLASSE ENERGETICA	IMBALLO
LR51	10	230	420	5500	120°	≥70	NERO	COB bianco/rosso/blu		10/20



Ingresso Micro USB
Presa per la ricarica



Uscita USB

SOS

Interruttore
Luce/Dimmer

Indicatore di batteria

CAPACITA' BATTERIA: 2X2000mAh

funzione POWER BANK tramite USB

SELEZIONATORE POTENZA: 5W / 10W

SOS: luce alternata BLU/ROSSA

ULTRASOTTILE con MAGNETI

INPUT: 5V 1A USB

OUTPUT: 2.0A USB

CAVO RICARICA incluso



**SISTEMA A BINARIO
E ACCESSORI**



Il sistema di illuminazione a binario offre una grande flessibilità d'installazione, consentendo di collegare diversi corpi illuminanti su un'unica linea. Il design moderno si integra perfettamente in ambienti domestici, retail e uffici, mentre il materiale in alluminio assicura durata nel tempo. La nostra gamma comprende sia versioni a 2 pin che a 4 pin, insieme a tutti gli accessori necessari per configurare soluzioni su misura per ogni spazio.

The track lighting system offers a great level of installation flexibility, allowing several luminaires to be connected on a single line. The modern design fits perfectly in any domestic, retail or office environment, while the aluminum material ensures durability. Our range includes both 2-pin and 4-pin versions, as well as all the accessories needed to configure tailor-made solutions for any space.



BINARI 2 pin - MONOFASE



CODICE ARTICOLO	DESCRIZIONE	VOLT	IP	MATERIALE	COLORE	DIMENSIONI	IMBALLO
C-TP-0221MB	binario 1M - 2PIN	230	IP20	METALLO	BIANCO	930x35 H18 mm	1
C-TP-0221MN	binario 1M - 2PIN	230	IP20	METALLO	NERO	930x35 H18 mm	1
C-TP-0222MB	binario 2M - 2PIN	230	IP20	METALLO	BIANCO	1930x35 H18 mm	1
C-TP-0222MN	binario 2M - 2PIN	230	IP20	METALLO	NERO	1930x35 H18 mm	1

CODICE ARTICOLO	DESCRIZIONE	VOLT	IP	MATERIALE	COLORE	DIMENSIONI mm	IMBALLO
C-TP-023B	MINI connettore centrale	230	IP20	PLASTICA	BIANCO	80x35 H18	1
C-TP-023N	MINI connettore centrale	230	IP20	PLASTICA	NERO	80x35 H18	1
C-TP-030B	connettore flessibile	230	IP20	PLASTICA	BIANCO	270x35 H18	1
C-TP-030N	connettore flessibile	230	IP20	PLASTICA	NERO	270x35 H18	1
C-TP-028B	connettore di alimentazione	230	IP20	PLASTICA	BIANCO	108,5x35 H18	1
C-TP-028N	connettore di alimentazione	230	IP20	PLASTICA	NERO	108,5x35 H18	1
C-TP-024B	connettore centrale	230	IP20	PLASTICA	BIANCO	182x35 H18	1
C-TP-024N	connettore doppio	230	IP20	PLASTICA	NERO	182x35 H18	1
C-TP-026B	connettore a T	230	IP20	PLASTICA	BIANCO	182x35 H18	1
C-TP-026N	connettore a T	230	IP20	PLASTICA	NERO	182x35 H18	1
C-TP-027B	connettore a X	230	IP20	PLASTICA	BIANCO	182x35 H18	1
C-TP-027N	connettore a X	230	IP20	PLASTICA	NERO	182x35 H18	1
C-TP-025B	connettore a L	230	IP20	PLASTICA	BIANCO	108,5x35 H18	1
C-TP-025N	connettore a L	230	IP20	PLASTICA	NERO	108,5x35 H18	1
C-TP-029B	tappo di chiusura	230	IP20	PLASTICA	BIANCO	5x35 H18	1
C-TP-029N	tappo di chiusura	230	IP20	PLASTICA	NERO	5x35 H18	1
C-TP-032B	KIT sospensione	230	IP20	PLASTICA	BIANCO	---	1
C-TP-032N	KIT sospensione	230	IP20	PLASTICA	NERO	---	1
C-TP-050B	adattatore pendant	230	IP20	PLASTICA	BIANCO	---	1
C-TP-050N	adattatore pendant	230	IP20	PLASTICA	NERO	---	1

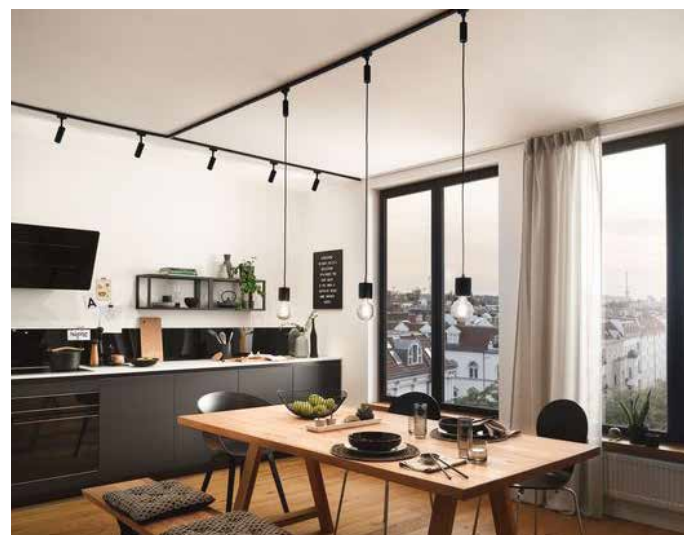



BINARI 4 pin - TRIFASE



CODICE ARTICOLO	DESCRIZIONE	VOLT	IP	MATERIALE	COLORE	DIMENSIONI	IMBALLO
C-TSDL4101MB	binario 1M - 4PIN	230	IP20	METALLO	BIANCO	32x36x100 m	1
C-TSDL4101MN	binario 1M - 4PIN	230	IP20	METALLO	NERO	32x36x100 m	1
C-TSDL4102MB	binario 2M - 4PIN	230	IP20	METALLO	BIANCO	32x36x200 m	1
C-TSDL4102MN	binario 2M - 4PIN	230	IP20	METALLO	NERO	32x36x200 m	1

CODICE ARTICOLO	DESCRIZIONE	VOLT	IP	MATERIALE	COLORE	DIMENSIONI mm	IMBALLO
C-TP-460B	MINI connettore centrale	230	IP20	PLASTICA	BIANCO	75x31 H26	1
C-TP-460N	MINI connettore centrale	230	IP20	PLASTICA	NERO	75x31 H26	1
C-TP-463FB	connettore flessibile	230	IP20	PLASTICA	BIANCO	236x33 H33	1
C-TP-463FN	connettore flessibile	230	IP20	PLASTICA	NERO	236x33 H33	1
C-TP-461BD	connettore di alimentazione DX	230	IP20	PLASTICA	BIANCO	100x31,5 H33	1
C-TP-461ND	connettore di alimentazione DX	230	IP20	PLASTICA	NERO	100x31,5 H33	1
C-TP-461BS	connettore di alimentazione SX	230	IP20	PLASTICA	BIANCO	100x31,5 H33	1
C-TP-461NS	connettore di alimentazione SX	230	IP20	PLASTICA	NERO	100x31,5 H33	1
C-TP-462B	connettore centrale	230	IP20	PLASTICA	BIANCO	165x31,5 H33	1
C-TP-462N	connettore centrale	230	IP20	PLASTICA	NERO	165x31,5 H33	1
C-TP-464B	connettore a T	230	IP20	PLASTICA	BIANCO	165x31,5 H33	1
C-TP-464B	connettore a T	230	IP20	PLASTICA	NERO	165x31,5 H33	1
C-TP-465B	connettore a X	230	IP20	PLASTICA	BIANCO	165x31,5 H33	1
C-TP-465N	connettore a X	230	IP20	PLASTICA	NERO	165x31,5 H33	1
C-TP-463B	connettore a L	230	IP20	PLASTICA	BIANCO	98x31,5 H33	1
C-TP-463B	connettore a L	230	IP20	PLASTICA	NERO	98x31,5 H33	1
C-TP-466B	tappo di chiusura	230	IP20	PLASTICA	BIANCO	sp. 5mm H33	1
C-TP-466N	tappo di chiusura	230	IP20	PLASTICA	NERO	sp. 5mm H33	1
C-TP-491B	KIT sospensione	230	IP20	PLASTICA	BIANCO	---	1
C-TP-491N	KIT sospensione	230	IP20	PLASTICA	NERO	---	1





FARETTI 4pin per BINARIO TRIFASE

CE IP20

VOLT: AC220/240V - 50/60Hz
 materiale: Alluminio



TRUCK COB trifase

materiale: Alluminio



CE LIFE TIME 30.000 h IP20

CODICE ARTICOLO	WATT	VOLT	LUMEN	KELVIN	ANGOLO	CRI	COLORE	TIPO LED	ACCENSIONI	CLASSE ENERGETICA	IMBALLO
TRUCK303KB	30	230	2300	3000	24°	≥80	BIANCO	COB	4PIN		1/10



TRUCK COB trifase

materiale: Alluminio

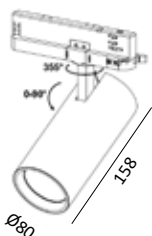

CE LIFE TIME 30.000 h IP20

CODICE ARTICOLO	WATT	VOLT	LUMEN	KELVIN	ANGOLO	CRI	COLORE	TIPO LED	ACCENSIONI	CLASSE ENERGETICA	IMBALLO
TRUCK303KN	30	230	3000	3000	36°	≥80	NERO	BRIDGE LUX	4PIN		1/10





FARETTI con attacco GU10

VOLT: AC220/240V - 50/60Hz

materiale: Alluminio

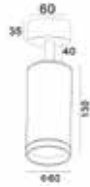

CODICE ARTICOLO	DESCRIZIONE	VOLT	ATTACCO	INSTALLAZIONE	COLORE	IMBALLO
DLC-B	FARO per GU10 con snodo	230	GU10 non inclusa	PARETE/SOFFITTO	BIANCO	1/30
DLC-N	FARO per GU10 con snodo	230	GU10 non inclusa	PARETE/SOFFITTO	NERO	1/30



CODICE ARTICOLO	DESCRIZIONE	VOLT	ATTACCO	INSTALLAZIONE	COLORE	IMBALLO
DLW-B	FARO per GU10	230	GU10 non inclusa	SOFFITTO	BIANCO	1/50
DLW-N	FARO per GU10	230	GU10 non inclusa	SOFFITTO	NERO	1/50

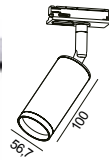

CODICE ARTICOLO	DESCRIZIONE	VOLT	ATTACCO	INSTALLAZIONE	COLORE	IMBALLO
DLT-B	FARO per GU10 da binario MONOFASE	230	GU10 non inclusa	SOFFITTO	BIANCO	1/50
DLT-N	FARO per GU10 da binario MONOFASE	230	GU10 non inclusa	SOFFITTO	NERO	1/50



CODICE ARTICOLO	DESCRIZIONE	VOLT	ATTACCO	INSTALLAZIONE	COLORE	IMBALLO
DLP-B	FARO per GU10 a sospensione	230	GU10 non inclusa	SOFFITTO	BIANCO	1/30
DLP-N	FARO per GU10 a sospensione	230	GU10 non inclusa	SOFFITTO	NERO	1/30

**LUCI SEGNAPASSO E EMERGENZA
A LED**



Luci LED segnapasso con installazione ad incasso in scatole 503 o per montaggio esterno. Progettate per illuminare verso il basso, offrono un'illuminazione confortevole senza abbagliare.

Le luci LED d'emergenza, complete di accessori, sono progettate per illuminare scale e corridoi. Offrono una guida luminosa che facilita l'orientamento in situazioni critiche.

LED step lights with recessed installation in 503 boxes or for outdoor mounting. Designed to illuminate downward, they provide comfortable lighting without dazzling.

Emergency LED lights, complete with accessories, are designed to illuminate stairways and hallways. They offer light guidance that facilitates orientation in critical situations.

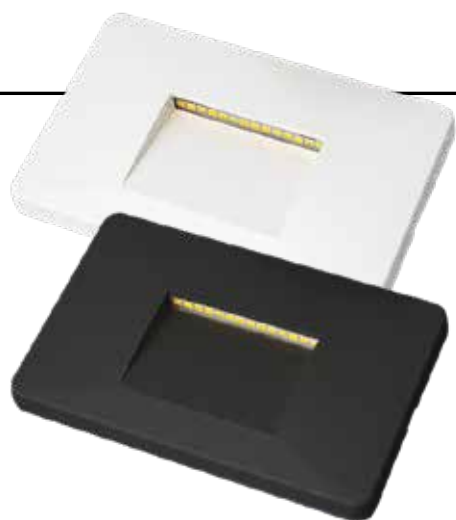

LUCE SEGNAPASSO LED 3W - IP65

VOLT: AC220-240V - 50/60Hz



Si abbina alle
**SCATOLE
DA INCASSO 503**

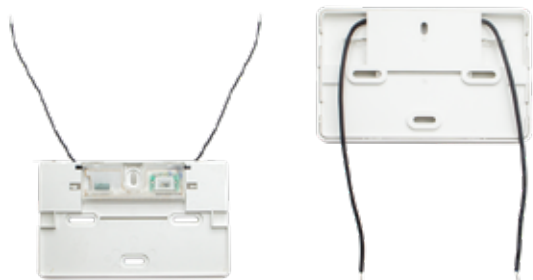

FONTE LUMINOSA

CODICE ARTICOLO	WATT	VOLT	LUMEN	KELVIN	ANGOLO	CRI	COLORE	DIMENSIONI	CLASSE ENERGETICA	IMBALLO
● SPI3CCT	3	230	150	3CCT 3000K 4000K 6500K	90°	80	BIANCO	130X85X13 mm		1/50

COVER

CODICE ARTICOLO	DESCRIZIONE	COLORE	IMBALLO
● COI3B	COVER IN ABS PER SPI3CCT	BIANCO	1/100
● COI3N	COVER IN ABS PER SPI3CCT	NERO	1/100

**LUCE SEGNAPASSO LED 4W - IP65**

VOLT: AC220-240V - 50/60Hz

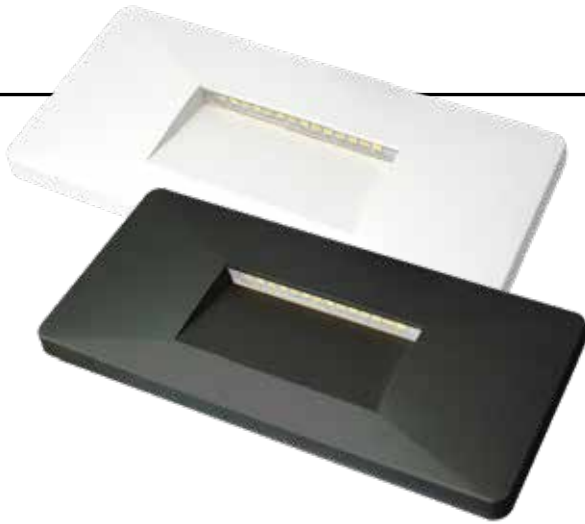

Si abbina alle
**SCATOLE
DA INCASSO 503**

**FONTE LUMINOSA**

CODICE ARTICOLO	WATT	VOLT	LUMEN	KELVIN	ANGOLO	CRI	COLORE	DIMENSIONI	CLASSE ENERGETICA	IMBALLO
• SPI4CCT	4	230	240	3CCT 3000K 4000K 6500K	90°	80	BIANCO	190X90X13,5 mm		1/50

COVER

CODICE ARTICOLO	DESCRIZIONE	COLORE	IMBALLO
• COI4B	COVER IN ABS PER SPI4CCT	BIANCO	1/100
• COI4N	COVER IN ABS PER SPI4CCT	NERO	1/100





LUCE SEGNAPASSO da PARETE LED 5W - IP65

VOLT: AC220-240V - 50/60Hz

MATERIALE: ABS

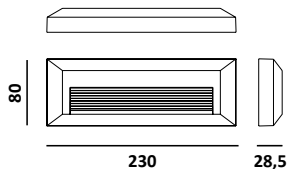

CODICE ARTICOLO	WATT	VOLT	LUMEN	KELVIN	ANGOLO	CRI	COLORE	DIMENSIONI	CLASSE ENERGETICA	IMBALLO
• SPECCTB	5	230	400	3CCT 3000K 4000K 6500K	100°	80	BIANCO	230X80X28,5 mm		1/25
• SPECCTN	5	230	400	3CCT 3000K 4000K 6500K	100°	80	NERO	230X80X28,5 mm		1/25



VEGA IP20

materiale: Policarbonato

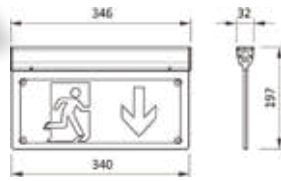





CODICE ARTICOLO	WATT	VOLT	LUMEN	KELVIN	ANGOLO	CRI	TIPO LED	AUTONOMIA EMERGENZA	IMBALLO
VEGA	3,5	230	19	4000	60°	≥80	12*SMD 3030	3h	1/12

MODALITA' LUCE EMERGENZA:
LUCE SEMPRE ACCESA (SA)*

BATTERIA: Ni-CA AA800mAh 7,2V

ACCESSORI serie VEGA

INDICAZIONI DIREZIONALI

CODICE ARTICOLO	CODICE ARTICOLO
 VEGAUP	 VEGALEFT
 VEGADOWN	 VEGARIGHT

CATENELLA SOSPENSIONE

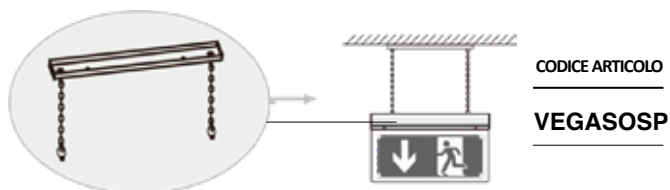

**PANNELLI PROFESSIONALI
A LED**



I pannelli a LED di alta prestazione garantiscono un elevato comfort di illuminazione. Con un valore UGR inferiore a 19, riducono il riverbero e l'affaticamento visivo, rendendoli ideali per uffici, scuole, ospedali e spazi pubblici. Il design minimalista, l'efficienza energetica e i materiali di alta qualità assicurano un'illuminazione uniforme e performante.

High-performance LED panels provide high lighting comfort. With a UGR value of less than 19, they reduce glare and eye fatigue, making them ideal for offices, schools, hospitals, and public spaces. Minimalist design, energy efficiency and high-quality materials ensure uniform and high-performance lighting.



PANNELLO professionale UGR<13 - CRI80

materiale: Alluminio

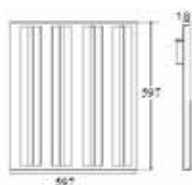
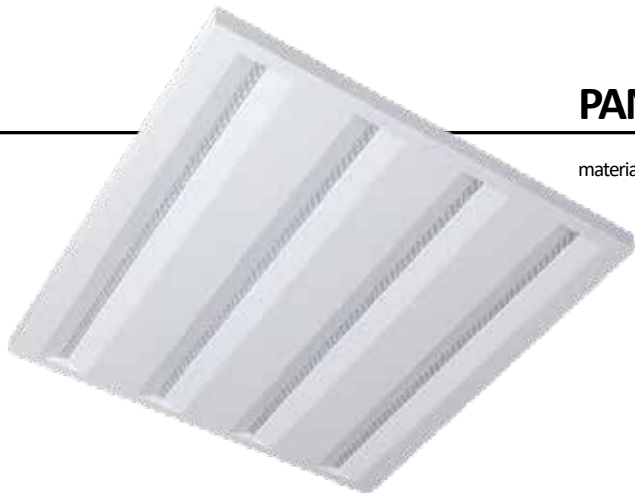

CODICE ARTICOLO	WATT	VOLT	LUMEN	KELVIN	ANGOLO	CRI	COLORE	TIPO LED	DRIVER	CLASSE ENERGETICA	IMBALLO
PAL36LENS	36	230	4200	4000	75°	≥80	BIANCO	moduli LED con lenti	PHILIPS o equivalente		1/5
PAL45LENS	45	230	5200	4000	75°	≥80	BIANCO	moduli LED con lenti	PHILIPS o equivalente		1/5

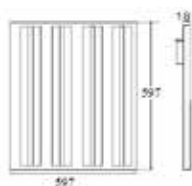

CODICE ARTICOLO	WATT	VOLT	LUMEN	KELVIN	ANGOLO	CRI	COLORE	TIPO LED	DRIVER	CLASSE ENERGETICA	IMBALLO
PAL45CCT-DIMM	45	230	5200	bianco dinamico 2.7-6K*	75°	≥80	BIANCO	moduli LED con lenti	PHILIPS o equivalente		1/5

*Funziona solo con telecomando **TLCPAL45CCT**

accessori



CODICE ARTICOLO	DESCRIZIONE
CORN PAL36-45	CORNICE DI FINITURA PER IL MONTAGGIO ESTERNO DEL PANNELLO
CLIP PAL36-45	CLIP A MOLLA PER IL MONTAGGIO IN CONTROSOFFITTO DEL PANNELLO
SOSP PAL3645	KIT DI SOSPENSIONE PER IL MONTAGGIO A SOFFITTO DEL PANNELLO
TLC PAL45CCT	* TELECOMANDO PER PANNELLO PAL45CCT-DIMM
CNTR PAL45CCT	* CONTROLLO WIRELESS A MURO PER PANNELLO PAL45CCT-DIMM
SENSPAL45CCT	SENSORE DI LUCE AMBIENTALE PER PANNELLO PAL45CCT-DIMM

PARTI DI RICAMBIO

CODICE ARTICOLO	DESCRIZIONE
PR046	DRIVER DI RICAMBIO PER PAL36LENS
PR047	DRIVER DI RICAMBIO PER PAL45LENS
PR048	DRIVER DI RICAMBIO PER PAL45CCT-DIMM

**PANNELLO** professionale **UGR<19 (16.9) - CRI90**

materiale: Acciaio + Policarbonato



retro



diffusore prismatico



CODICE ARTICOLO	WATT	VOLT	LUMEN	KELVIN	ANGOLO	CRI	COLORE	TIPO LED	CLASSE ENERGETICA	IMBALLO
PAL4017	40	230	3600	4000	120°	≥90	BIANCO	SMD4014		1/5

**PANNELLO** professionale **UGR<19 (16.9) - CRI90**

materiale: Acciaio + Policarbonato



diffusore prismatico



retro

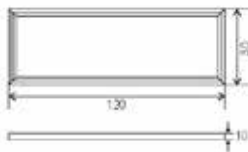

CODICE ARTICOLO	WATT	VOLT	LUMEN	KELVIN	ANGOLO	CRI	COLORE	TIPO LED	CLASSE ENERGETICA	IMBALLO
PAL30120	40	230	3600	4000	120°	≥90	BIANCO	SMD4014		1/5

accessori

CODICE ARTICOLO	DESCRIZIONE
-----------------	-------------

CORNICEPAL CORNICE BIANCA DI FINITURA PER IL MONTAGGIO ESTERNO DEL PANNELLO PAL4017**CORNICEPAL30120** CORNICE BIANCA DI FINITURA PER IL MONTAGGIO ESTERNO DEL PANNELLO PAL30120**SOSPENSAPAL** KIT DI SOSPENSIONE PER IL MONTAGGIO A SOFFITTO DEL PANNELLO PAL4017/ PAL30120**MOLLEPAL** CLIP A MOLLA PER IL MONTAGGIO IN CONTROSOFFITTO DEL PANNELLO PAL4017/ PAL30120**PARTI DI RICAMBIO**

CODICE ARTICOLO	DESCRIZIONE
PR049	DRIVER DI RICAMBIO PER PAL4017/PAL30120

**FARI PROFESSIONALI
A LED**



La serie Corel di fari professionali a LED offre un'illuminazione di alta qualità grazie a una tecnologia avanzata, ideale per illuminare grandi spazi esterni e interni. Progettati per garantire alte prestazioni, utilizzano materiali e lenti di eccellente qualità. Ogni prodotto è coperto da 5 anni di garanzia, offrendo un investimento duraturo e sostenibile.

Corel's series of professional LED floodlights offer high-quality illumination thanks to advanced technology, ideal for lighting large outdoor and indoor spaces. Designed to guarantee high performance, they are made of high quality materials and lenses. Each product is under 5-year warranty, offering a long-lasting and sustainable investment.



VOLT: AC100-240V/277V - 50/60Hz
CAVO ALIMENTAZIONE 1MT
 materiale: Alluminio + Policarbonato/Vetro



CODICE ARTICOLO	WATT	LUMEN	OTTICA	KELVIN	PF	CRI	COLORE	EFFICIENZA	TIPO LED	DIMENSIONI	MONTAGGIO	IMBALLO
XLINE80W-4K	80	11200	110°	4K	>0.95	≥70	SILVER	140 lm/w	PHILIPS LUMILED	355x370x200	staffe	1
XLINE80W-5K	80	11200	110°	5K	>0.95	≥70	SILVER	140 lm/w	PHILIPS LUMILED	355x370x200	staffe	1
XLINE120W-5K	120	16800	110°	5K	>0.95	≥70	SILVER	140 lm/w	PHILIPS LUMILED	430x370x200	staffe	1

ottiche

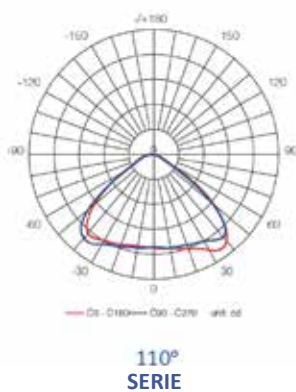
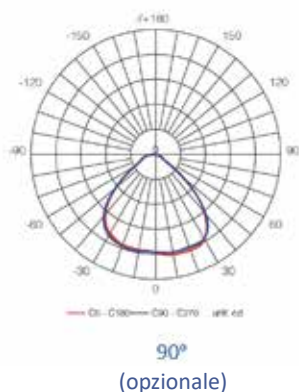
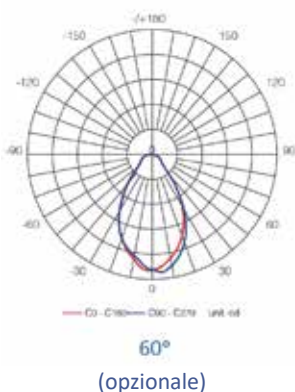

THD <15%
L70 25° >100.000h

installazione

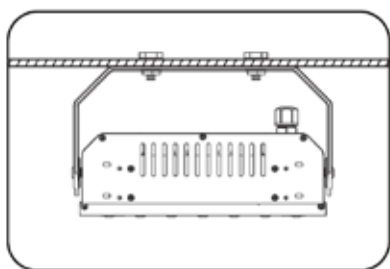

staffa a soffitto/plafone

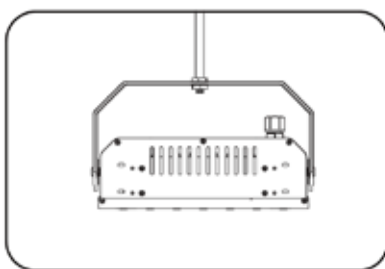

staffa a sospensione

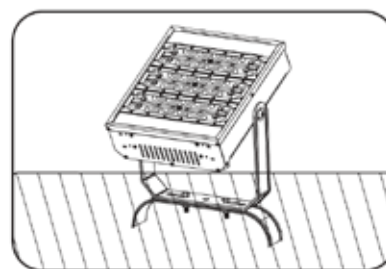

staffa a terra

Ricambi

MODULI LED

- PR013** MODULO LED 3030 4K 110° per serie XLINE
- PR014** MODULO LED 3030 5K 110° per serie XLINE
- PR015** MODULO LED 5050 4K 110° per serie XLINE
- PR016** MODULO LED 5050 5K 110° per serie XLINE

DRIVER

- PR033** DRIVER PER XLINE 40W
- PR032** DRIVER PER XLINE 80W
- PR034** DRIVER PER XLINE 120W
- PR035** DRIVER PER XLINE 160W
- PR036** DRIVER PER XLINE 200W

OTTICHE

- PR009** LENTE OTTICA PC 110°X110° PER XLINE
- PR010** LENTE OTTICA PC 150°X65° PER XLINE
- PR011** LENTE OTTICA PC 60°X60° PER XLINE
- PR012** LENTE OTTICA PC 145°X100° PER XLINE

CORNICI PER INCASSO

- CORNICE80** CORNICE PER INCASSO per XLINE 80W
304*316*H120mm
- CORNICE120** CORNICE PER INCASSO per XLINE 120W
377*316*H120mm

serie **Z-LINE**

VOLT: AC100-240V/277V - 50/60Hz

CAVO ALIMENTAZIONE 1MT

materiale: Alluminio + Policarbonato/Vetro

INVENTRONICS
LED DRIVER inside5 ANNI
GARANZIA

CODICE ARTICOLO	WATT	LUMEN	OTTICA	KELVIN	PF	CRI	COLORE	EFFICIENZA	TIPO LED	DIMENSIONI	MONTAGGIO	IMBALLO
Z-LINE80-4K	80	11600	90°	4000	>0.95	≥70	GRIGIO	145 lm/w	PHILIPS LUMILED 3030 2D	425*385*140	staffa	1
Z-LINE80-5K	80	11600	90°	5000	>0.95	≥70	GRIGIO	145 lm/w	PHILIPS LUMILED 3030 2D	425*385*140	staffa	1
Z-LINE120-4K	120	17400	90°	4000	>0.95	≥70	GRIGIO	145 lm/w	PHILIPS LUMILED 3030 2D	425*385*140	staffa	1
Z-LINE120-5K	120	17400	90°	5000	>0.95	≥70	GRIGIO	145 lm/w	PHILIPS LUMILED 3030 2D	425*385*140	staffa	1
Z-LINE150-4K	150	21750	90°	4000	>0.95	≥70	GRIGIO	145 lm/w	PHILIPS LUMILED 3030 2D	470*443*143	staffa	1
Z-LINE150-5K	150	21750	90°	5000	>0.95	≥70	GRIGIO	145 lm/w	PHILIPS LUMILED 3030 2D	470*443*143	staffa	1
Z-LINE200-4K	200	29000	90°	4000	>0.95	≥70	GRIGIO	145 lm/w	PHILIPS LUMILED 3030 2D	470*443*143	staffa	1
Z-LINE200-5K	200	29000	90°	5000	>0.95	≥70	GRIGIO	145 lm/w	PHILIPS LUMILED 3030 2D	470*443*143	staffa	1
Z-LINE320-4K	200	49600	90°	4000	>0.95	≥70	GRIGIO	155 lm/w	PHILIPS LUMILED 3030 2D	655*570*180	staffa	1
Z-LINE320-5K	320	49600	90°	5000	>0.95	≥70	GRIGIO	155 lm/w	PHILIPS LUMILED 3030 2D	655*570*180	staffa	1

THD <15%

L70 25° >100.000h

ottiche

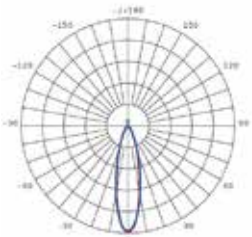
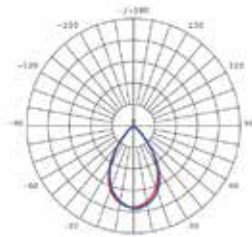
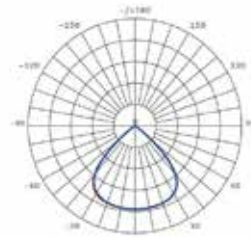
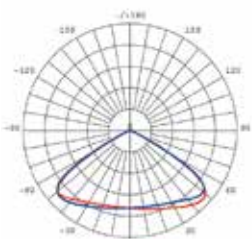
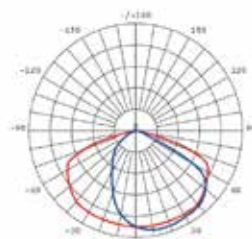
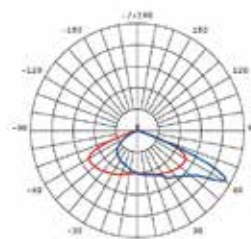
30°
(opzionale)60°
(opzionale)90°
SERIE120°
(opzionale)asimmetrica1
(opzionale)asimmetrica2
(opzionale)

Ricambi

DRIVER

- PR005** DRIVER INVENTRONICS PER ZLINE 80W
- PR007** DRIVER INVENTRONICS PER ZLINE 120W
- PR006** DRIVER INVENTRONICS PER ZLINE 150W
- PR008** DRIVER INVENTRONICS PER ZLINE 200W

OTTICHE

- PR001** LENTE OTTICA AS1 PC PER ZLINE
- PR002** LENTE OTTICA 60° PC PER ZLINE
- PR003** LENTE OTTICA AS2 PC PER ZLINE

installazione

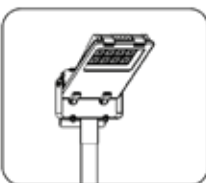

Montaggio su PALO

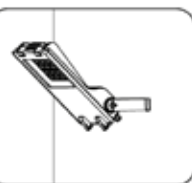
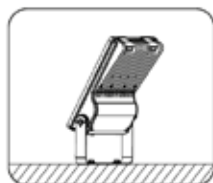
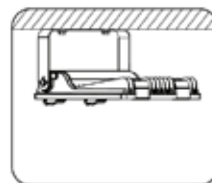
Montaggio con
STAFFA a PARETEMontaggio con
STAFFA a PLAFONE



serie M-LINE dimmerabile



VOLT: AC100-240V/277V - 50/60Hz

DIMMER OPTION: 1-10V

CAVO ALIMENTAZIONE 1MT

materiale: Alluminio + Policarbonato



CODICE ARTICOLO	WATT	LUMEN	KELVIN	OTTICA	PF	CRI	COLORE	EFFICIENZA	TIPO LED	IMBALLO
MLINE200WDI5-5K	200	29000	5000	110°	>0.95	≥70	NERO	145 lm/w	PHILIPS LUMILED 3030 2D	1

DIMENSIONI: 375*375*165 mm



ottiche

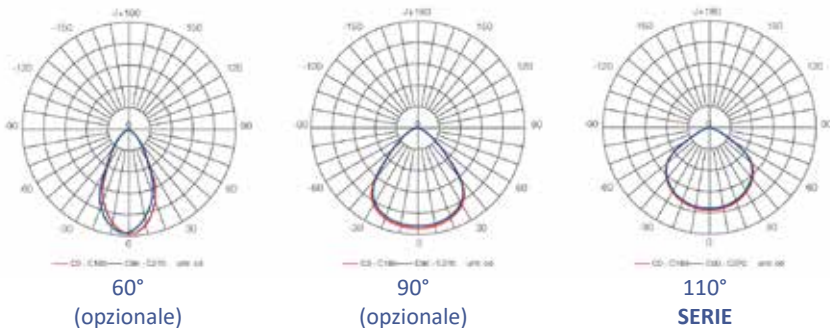

THD <10%
L70 25° >50.000h

installazione

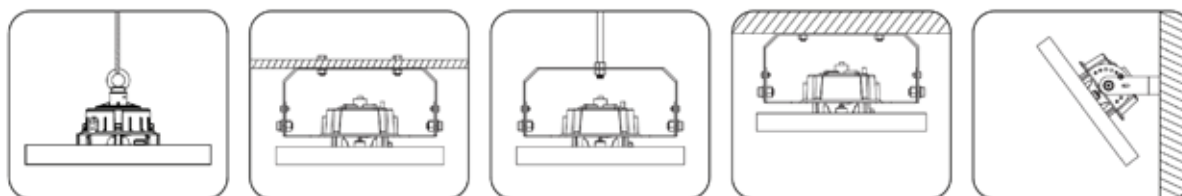

accessori



sensore di presenza
 per MLINE 200D
 PR031

Ricambi

DRIVER
PR024 DRIVER PER MLINE 200WDI5

OTICHE
PR017 OTTICA 60° PER MLINE serie DI5



serie M-LINE

VOLT: AC100-240V/277V - 50/60Hz
CAVO ALIMENTAZIONE 1MT
materiale: Alluminio + Policarbonato + cover Vetro



CODICE ARTICOLO	WATT	LUMEN	KELVIN	OTTICA	PF	CRI	COLORE	lumen/watt	TIPO LED	IMBALLO
M-LINE200-5K	200	28000	5000	110°	>0.95	≥70	NERO	140	PHILIPS LUMILED 3030 2D	1
M-LINE200-5K DALI	200	28000	5000	110°	>0.95	≥70	NERO	140	PHILIPS LUMILED 3030 2D	1



DIMENSIONI: 365*365*210 mm

ottiche

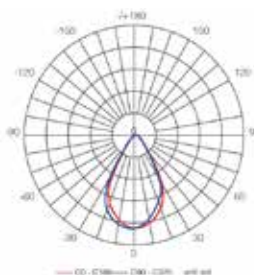

60°
(opzionale)

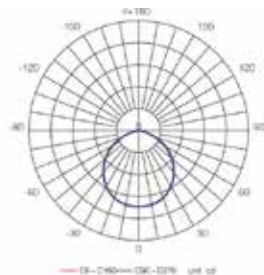

110°
SERIE

THD <10%

L70 25° >100.000h

installazione

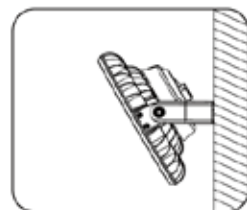
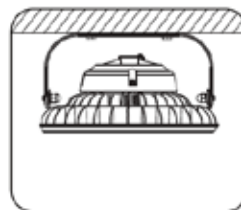
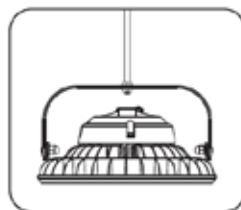
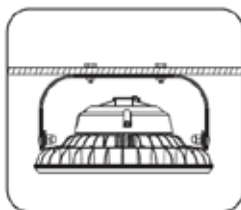

accessori



sensore di presenza
SENSORE MLINE

Ricambi

DRIVER

PR025 DRIVER PER MLINE 200W

PR027 DRIVER PER MLINE 200W DALI



serie K-MINI

VOLT: AC100-240V/277V - 50/60Hz
 materiale: Alluminio + Policarbonato/Vetro

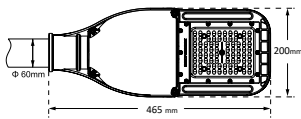

CODICE ARTICOLO	WATT	LUMEN	OTTICA	KELVIN	N. MODULI	Q.TA' LED/Assorb	PF	CRI	COLORE	TIPO LED	IMBALLO
SL38KMINI-5	38	4940	2M	5000	1	56/100mA	>0.95	≥70	GRIGIO	PHILIPS LUMILED 3030 2D	1
SL57KMINI-5	57	7410	2M	5000	1	80/100mA	>0.95	≥70	GRIGIO	PHILIPS LUMILED 3030 2D	1

DIMENSIONI: 465*200*h100 mm
 diam. palo 60mm

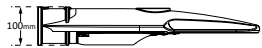

ottiche

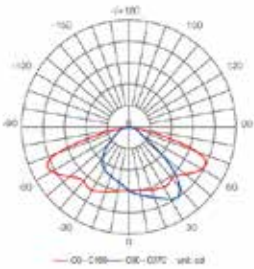

2M
(serie)

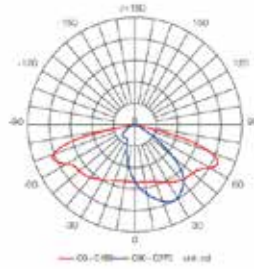

2M BLS
(opzionale)

THD <20%

L70 25° >100.000h

installazione

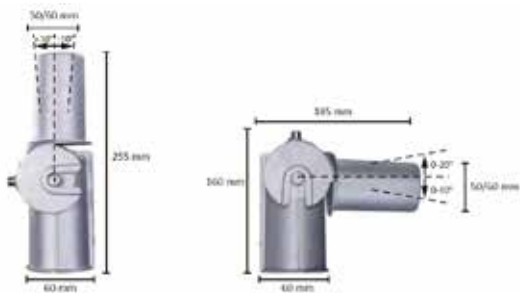

ADATTATORE PER SNODO SL90° (opzionale)

PR019

adattatori

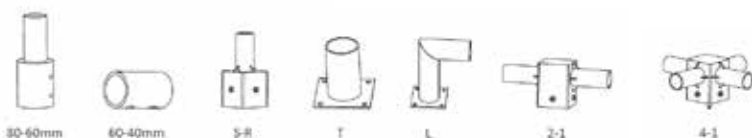

Ricambi

DRIVER

PR044 DRIVER PER SL38KMINI

PR045 DRIVER PER SL57KMINI



serie K-MINI

VOLT: AC100-240V/277V - 50/60Hz
materiale: Alluminio + Policarbonato/Vetro

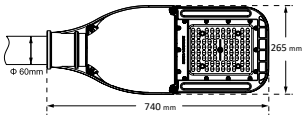

CODICE ARTICOLO	WATT	LUMEN	OTTICA	KELVIN	N. MODULI	PF	CRI	COLORE	DIMENSIONI	TIPO LED	IMBALLO
SL100KMINI-5	100	16000	T2M3025	5000	1	>0.95	≥70	GRIGIO	740*265*h88 diam. palo 60mm	PHILIPS LUMILED 3030 2D	1
SL150KMINI-5	150	24000	T2M3025	5000	1	>0.95	≥70	GRIGIO	740*265*h88 diam. palo 60mm	PHILIPS LUMILED 3030 2D	1

ottiche

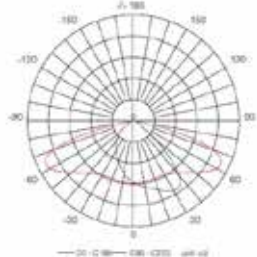

T2M3025 (serie)

THD <20%

L70 25° >100.000h

installazione



ADATTATORE PER SNODO SL90° (opzionale)

PR019

adattatori

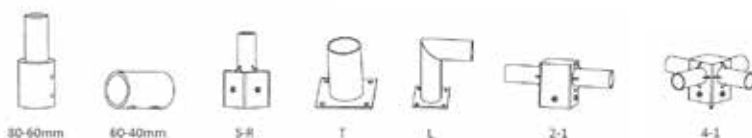

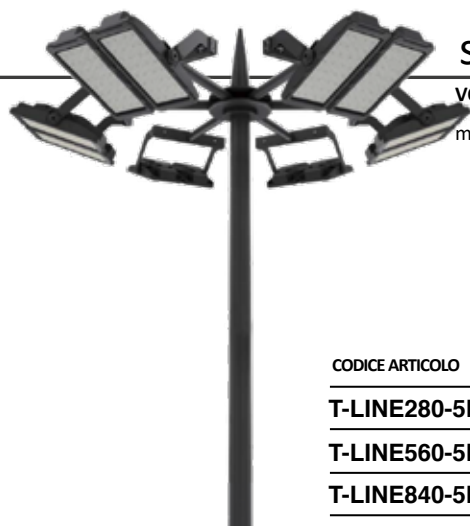

serie T-LINE

VOLT: AC100-240V/277V - 50/60Hz

materiale: Alluminio + Policarbonato/Vetro



INVENTRONICS
LED DRIVER inside



CODICE ARTICOLO	WATT	LUMEN	OTTICA	KELVIN	EFFICIENZA	PF	CRI	COLORE	DIMENSIONI	TIPO LED	IMBALLO
T-LINE280-5K	280	42000	45°	5000	150 lm/w	>0.95	≥75	NERO	770*385*h235	PHILIPS LUMILED 3030 2D	1
T-LINE560-5K	560	84000	45°	5000	150 lm/w	>0.95	≥75	NERO	770*640*h235	PHILIPS LUMILED 3030 2D	1
T-LINE840-5K	840	126000	45°	5000	150 lm/w	>0.95	≥75	NERO	770*900*h235	PHILIPS LUMILED 3030 2D	1

THD <20%

L70 25° >100.000h

ottiche

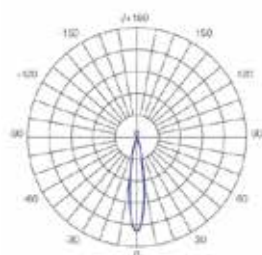

15°
(opzionale)

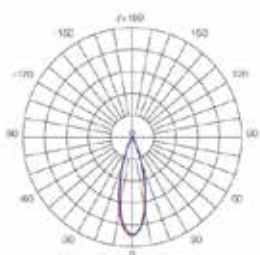

30°
(opzionale)

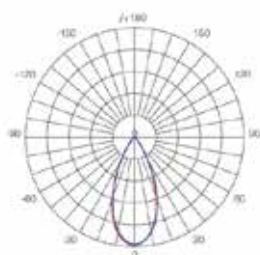

45°
SERIE

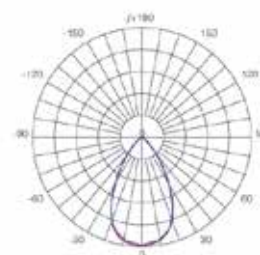

60°
(opzionale)

installazione

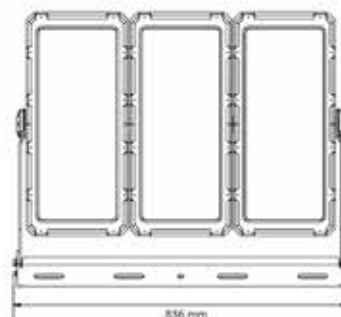
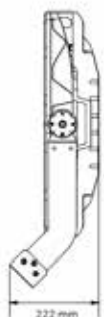

Ricambi

DRIVER

PR026 DRIVER PER TLINE 280W



serie S-LINE

VOLT: AC100-240V/277V - 50/60Hz
materiale: Alluminio + Policarbonato/Vetro



CODICE ARTICOLO	WATT	LUMEN	OTTICA	KELVIN	N. MODULI	ANGOLO	PF	CRI	COLORE	DIMENSIONI	TIPO LED	IMBALLO
S-LINE80-5K	80	11200	2M	5000	1	H155°xV65°	>0.95	≥70	GRIGIO	504*316*136	PHILIPS LUMILED 3030 2D	1
S-LINE120-5K	120	16800	2M	5000	1	H155°xV65°	>0.95	≥70	GRIGIO	577*316*136	PHILIPS LUMILED 3030 2D	1
S-LINE160-5K	160	22400	2M	5000	1	H155°xV65°	>0.95	≥70	GRIGIO	650*316*136	PHILIPS LUMILED 3030 2D	1

ottiche

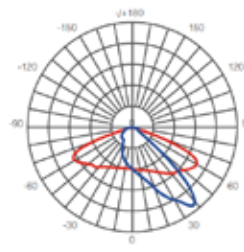
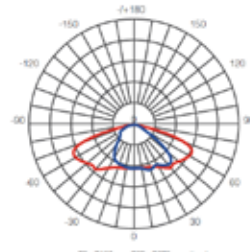
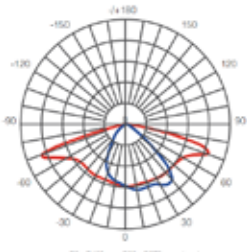

THD <20%

L70 25° >100.000h

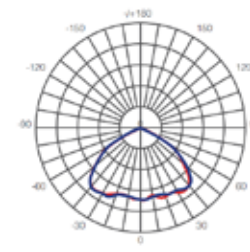
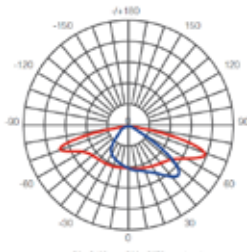

installazione



H0

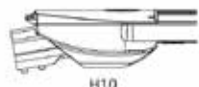

H10

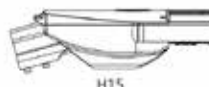

H15

Horizontal / Horizontal / Horizontal

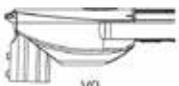

V0



V5



V15

Vertical / Vertical / Vertical

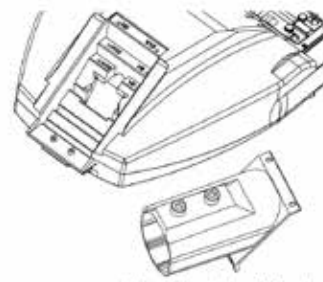

**PROFILI LED e ACCESSORI
DRIVER**



La nostra linea di profili LED, con le sue diverse sezioni, fornisce soluzioni ideali per ogni esigenza d'illuminazione. I profili LED combinano estetica elegante e funzionalità, rendendoli adatti ad ambienti residenziali e commerciali.

La selezione di driver LED di Corel offre molte opzioni per personalizzare l'utilizzo dell'illuminazione a LED in base al proprio progetto, garantendo versatilità.

Our LED profile line, with its different sections, provides ideal solutions for every lighting need. LED profiles combine elegant aesthetics and functionality, making them suitable for residential and commercial environments.

Corel's selection of LED drivers offers many options for customizing the use of LED lighting to suit your project, ensuring versatility.



PROFILO SLIM per strisce LED

CODICE ARTICOLO	MATERIALE	COLORE	DIMENSIONE	IMBALLO
SDPL10	ALLUMINIO	GRIGIO	2 m	1
SDPL10W	ALLUMINIO	BIANCO	2 m	1
SDPL10B	ALLUMINIO	NERO	2 m	1

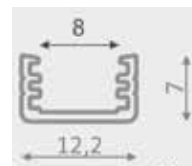



ADATTO PER STRIP LED 100/200/700/720





accessori

cover	CODICE ARTICOLO	MATERIALE	COLORE	DIMENSIONE	IMBALLO
	SDCL1	PC	smerigliata	2 m	1
	SDCL2	PC	trasparente	2 m	1
	SDCL10B	PC	bianca	2 m	1

tappi

	CODICE ARTICOLO	MATERIALE	COLORE	QUANTITA'	IMBALLO
	SDEND1	ABS	GRIGIO	2pz	1
	SDEND1W	ABS	BIANCO	2pz	1
	SDEND1B	ABS	NERO	2pz	1

kit fissaggio

	CODICE ARTICOLO	MATERIALE	COLORE	QUANTITA'	IMBALLO
	SDCON1	METALLO	GRIGIO	2supporti + 4viti	1
	SDCON12	METALLO	GRIGIO	2supporti + 4viti	1
	SDCON12W	METALLO	BIANCO	2supporti + 4viti	1
	SDCON12B	METALLO	NERO	2supporti + 4viti	1

angolo 90°

	CODICE ARTICOLO	MATERIALE	COLORE	QUANTITA'	IMBALLO
	SDANG10	ALLUMINIO	GRIGIO	1pz	1
	SDANG10W	ALLUMINIO	BIANCO	1pz	1
	SDANG10B	ALLUMINIO	NERO	1pz	1

PROFILO SURFACE per strisce LED

CODICE ARTICOLO	MATERIALE	COLORE	DIMENSIONE	IMBALLO
SDPL60	ALLUMINIO	GRIGIO	2 m	1
SDPL60W	ALLUMINIO	BIANCO	2 m	1
SDPL60B	ALLUMINIO	NERO	2 m	1

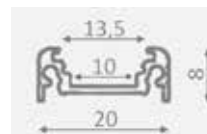



ADATTO PER STRIP LED 100/200/700/720/800/820/900/920/1000/1020/1320

accessori

cover	CODICE ARTICOLO	MATERIALE	COLORE	MONTAGGIO	DIMENSIONE	IMBALLO
	SDCL5	PC	smerigliata	a INFILARE	2 m	1
	SDCL6	PC	trasparente	a INFILARE	2 m	1
	SDCL12	PC	bianca	a INFILARE	2 m	1
	SDCL8	PC	trasparente	a CLICK	2 m	1
	SDCL9	PC	bianca	a CLICK	2 m	1

tappi

	CODICE ARTICOLO	MATERIALE	COLORE	QUANTITA'	IMBALLO
	SDEND5	ABS	GRIGIO	2pz	1
	SDEND5W	ABS	BIANCO	2pz	1
	SDEND5B	ABS	NERO	2pz	1

kit fissaggio

	CODICE ARTICOLO	MATERIALE	COLORE	QUANTITA'	IMBALLO
	SDCON3	ACCIAIO inox	GRIGIO	2piastre + 2viti	1
	SDCON4	ALLUMINIO	GRIGIO	1piastra + 1vite	1
	SDMOLLA	METALLO	GRIGIO	1 MOLLA	1

angolo 90°

	CODICE ARTICOLO	MATERIALE	COLORE	QUANTITA'	IMBALLO
	SDANG60	ALLUMINIO	GRIGIO	1pz	1
	SDANG60W	ALLUMINIO	BIANCO	1pz	1
	SDANG60B	ALLUMINIO	NERO	1pz	1



PROFILO CORNER per strisce LED

CODICE ARTICOLO	MATERIALE	COLORE	DIMENSIONE	IMBALLO
SDPL30	ALLUMINIO	GRIGIO	2 m	1
SDPL30W	ALLUMINIO	BIANCO	2 m	1
SDPL30B	ALLUMINIO	NERO	2 m	1

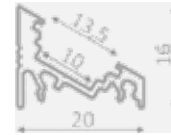



ADATTO PER STRIP LED 100/200/700/720/800/820/900/920/1000/1020/1320

accessori

cover	CODICE ARTICOLO	MATERIALE	COLORE	MONTAGGIO	DIMENSIONE	IMBALLO
	SDCL5	PC	smerigliata	a INFILARE	2 m	1
	SDCL6	PC	trasparente	a INFILARE	2 m	1
	SDCL12	PC	bianca	a INFILARE	2 m	1
	SDCL8	PC	trasparente	a CLICK	2 m	1
	SDCL9	PC	bianca	a CLICK	2 m	1

tappi

	CODICE ARTICOLO	MATERIALE	COLORE	QUANTITA'	IMBALLO
	SDEND3	ABS	GRIGIO	2pz	1
	SDEND3W	ABS	BIANCO	2pz	1
	SDEND3B	ABS	NERO	2pz	1

kit fissaggio

	CODICE ARTICOLO	MATERIALE	COLORE	QUANTITA'	IMBALLO
	SDCON3	ACCIAIO inox	GRIGIO	2piastre + 2viti	1
	SDCON4	ALLUMINIO	GRIGIO	1piastra + 1vite	1

angolo 90°

	CODICE ARTICOLO	MATERIALE	COLORE	QUANTITA'	IMBALLO
	SDANG30	ALLUMINIO	GRIGIO	1pz	1
	SDANG30W	ALLUMINIO	BIANCO	1pz	1
	SDANG30B	ALLUMINIO	NERO	1pz	1

PROFILO FLAT per strisce LED

CODICE ARTICOLO	MATERIALE	COLORE	DIMENSIONE	IMBALLO
SDPL100	ALLUMINIO	GRIGIO	2 m	1
SDPL100W	ALLUMINIO	BIANCO	2 m	1

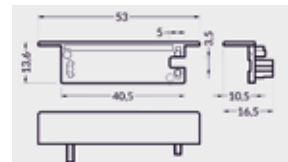



ADATTO PER STRIP LED 100/200/700/720/800/820/900/920/1000/1020/1320

accessori

cover	CODICE ARTICOLO	MATERIALE	COLORE	DIMENSIONE	IMBALLO
	SDCL14	PC	bianca	2 m	1
	SDCL15	PC	smerigliata	2 m	1

tappi

	CODICE ARTICOLO	MATERIALE	COLORE	QUANTITA'	IMBALLO
	SDEND8	ABS	GRIGIO	2pz	1
	SDEND8W	ABS	BIANCO	2pz	1

kit fissaggio

	CODICE ARTICOLO	MATERIALE	COLORE	MONTAGGIO	IMBALLO
	SDMOLLA	METALLO	GRIGIO	MOLLA	1



PROFILO GROOVE per strisce LED

CODICE ARTICOLO	MATERIALE	COLORE	DIMENSIONE	IMBALLO
SDPL70	ALLUMINIO	GRIGIO	2 m	1
SDPL70W	ALLUMINIO	BIANCO	2 m	1
SDPL70B	ALLUMINIO	NERO	2 m	1

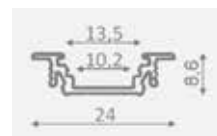

ADATTO PER STRIP LED 100/200/700/720/800/820/900/920/1000/1020/1320



accessori

cover	CODICE ARTICOLO	MATERIALE	COLORE	MONTAGGIO	DIMENSIONE	IMBALLO
	SDCL5	PC	smerigliata	a INFILARE	2 m	1
	SDCL6	PC	trasparente	a INFILARE	2 m	1
	SDCL12	PC	bianca	a INFILARE	2 m	1
	SDCL8	PC	trasparente	a CLICK	2 m	1
	SDCL9	PC	bianca	a CLICK	2 m	1

tappi

	CODICE ARTICOLO	MATERIALE	COLORE	QUANTITA'	IMBALLO
	SDEND6	ABS	GRIGIO	2pz	1
	SDEND6W	ABS	BIANCO	2pz	1
	SDEND6B	ABS	NERO	2pz	1

kit fissaggio

	CODICE ARTICOLO	MATERIALE	COLORE	QUANTITA'	IMBALLO
	SDCON3	ACCIAIO inox	GRIGIO	2piastre + 2viti	1
	SDCON4 collegamento tra profili	ALLUMINIO	GRIGIO	1piastra + 1vite	1
	SDMOLLA	METALLO	GRIGIO	1 MOLLA	1

angolo 90°

	CODICE ARTICOLO	MATERIALE	COLORE	QUANTITA'	IMBALLO
	SDANG70	ALLUMINIO	GRIGIO	1pz	1
	SDANG70W	ALLUMINIO	BIANCO	1pz	1
	SDANG70B	ALLUMINIO	NERO	1pz	1

PROFILO WIDE per strisce LED

CODICE ARTICOLO	MATERIALE	COLORE	DIMENSIONE	IMBALLO
SDPL20	ALLUMINIO	GRIGIO	2 m	1
SDPL20W	ALLUMINIO	BIANCO	2 m	1
SDPL20B	ALLUMINIO	NERO	2 m	1

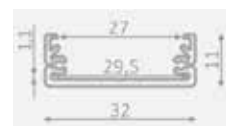

ADATTO PER STRIP LED 100/200/700/720/800/820/900/920/1000/1020/1320
1400/1500/1600/1620/1700



accessori

cover	CODICE ARTICOLO	MATERIALE	COLORE	MONTAGGIO	DIMENSIONE	IMBALLO
	SDCL3	PC	smerigliata	a INFILARE	2 m	1
	SDCL4	PC	trasparente	a INFILARE	2 m	1
	SDCL11	PC	bianca	a INFILARE	2 m	1

tappi

	CODICE ARTICOLO	MATERIALE	COLORE	QUANTITA'	IMBALLO
	SDEND2	ABS	GRIGIO	2pz	1
	SDEND2W	ABS	BIANCO	2pz	1
	SDEND2B	ABS	NERO	2pz	1

kit fissaggio

	CODICE ARTICOLO	MATERIALE	COLORE	QUANTITA'	IMBALLO
	SDCON2	METALLO	GRIGIO	2supporti + 4viti	1
	SDCON11	METALLO	GRIGIO	2supporti + 4viti	1
	SDCON11W	METALLO	BIANCO	2supporti + 4viti	1
	SDCON11B	METALLO	NERO	2supporti + 4viti	1



PROFILO PEN per strisce LED

CODICE ARTICOLO	MATERIALE	COLORE	DIMENSIONE	IMBALLO
SDPL40	ALLUMINIO	GRIGIO	2 m	1

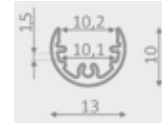

ADATTO PER STRIP LED 100/200/700/720/800/820/900/920/1000/1020/1320

accessori

cover	CODICE ARTICOLO	MATERIALE	COLORE	MONTAGGIO	DIMENSIONE	IMBALLO
	SDCL7	PC	smerigliata	a INFILARE	2 m	1

kit fissaggio	CODICE ARTICOLO	MATERIALE	COLORE	QUANTITA'	IMBALLO
	SDCON5 fissaggio piatto	METALLO	GRIGIO	2supporti + 2tappi ABS	1
	SDCON6	METALLO	GRIGIO	2supporti + 6viti	1
	SDCON7 fissaggio a soffitto	METALLO	GRIGIO	2supporti + 4viti	1

PROFILO OVAL per strisce LED



CODICE ARTICOLO	MATERIALE	COLORE	DIMENSIONE	IMBALLO
SDPL50	ALLUMINIO	GRIGIO	2 m	1



ADATTO PER STRIP LED 100/200/700/720/800/820/900/920/1000/1020/1320
1400/1500/1600/1620/1700

accessori

cover	CODICE ARTICOLO	MATERIALE	COLORE	MONTAGGIO	DIMENSIONE	IMBALLO
	SDCL5	PC	smerigliata	a INFILARE	2 m	1
	SDCL6	PC	trasparente	a INFILARE	2 m	1
	SDCL12	PC	bianca	a INFILARE	2 m	1
	SDCL8	PC	trasparente	a CLICK	2 m	1
	SDCL9	PC	bianca	a CLICK	2 m	1

kit fissaggio	CODICE ARTICOLO	MATERIALE	COLORE	QUANTITA'	IMBALLO
	SDEND4	METALLO/ ABS	GRIGIO	6 viti+ 2 tappi ABS+ 2 elem. assem- blaggio	1
	SDCON8	METALLO	GRIGIO	2 supporti + 4 viti	1

PROFILO ARC flessibile per strisce LED

CODICE ARTICOLO	MATERIALE	COLORE	DIMENSIONE	IMBALLO
SDPL80	ALLUMINIO	GRIGIO	2 m	1



ADATTO PER STRIP LED 100/200/700/720/800/820/900/920/1000/1020/1320

accessori

cover	CODICE ARTICOLO	MATERIALE	COLORE	MONTAGGIO	DIMENSIONE	IMBALLO
	SDCL8	PC	trasparente	a CLICK	2 m	1
	SDCL9	PC	bianca	a CLICK	2 m	1
	SDCL13	PC	bianca CURVA	a CLICK	2 m	1

tappi	CODICE ARTICOLO	MATERIALE	COLORE	QUANTITA'	IMBALLO
	SDEND7	ABS	GRIGIO	2pz	1

kit fissaggio	CODICE ARTICOLO	MATERIALE	COLORE	QUANTITA'	IMBALLO
	SDCON10	METALLO	GRIGIO	2 piastre + 2 viti inox	1



PROFILO DEEP per strisce LED

CODICE ARTICOLO	MATERIALE	COLORE	DIMENSIONE	IMBALLO
SDPL90	ALLUMINIO	GRIGIO	2 m	1
SDPL90W	ALLUMINIO	BIANCO	2 m	1
SDPL90B	ALLUMINIO	NERO	2 m	1

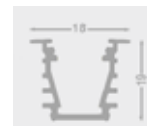

ADATTO PER STRIP LED 100/200/700/720/800/820/900/920/1000/1020/1320

accessori

cover	CODICE ARTICOLO	MATERIALE	COLORE	MONTAGGIO	DIMENSIONE	IMBALLO
	SDCL5	PC	smerigliata	a INFILARE	2 m	1
	SDCL6	PC	trasparente	a INFILARE	2 m	1
	SDCL12	PC	bianca	a INFILARE	2 m	1
	SDCL8	PC	trasparente	a CLICK	2 m	1
	SDCL9	PC	bianca	a CLICK	2 m	1

tappi	CODICE ARTICOLO	MATERIALE	COLORE	QUANTITA'	IMBALLO
	SDEND9	ABS	GRIGIO	2pz	1
	SDEND9W	ABS	BIANCO	2pz	1
	SDEND9B	ABS	NERO	2pz	1

kit fissaggio	CODICE ARTICOLO	MATERIALE	COLORE	QUANTITA'	IMBALLO
	SDCON3 fissaggio	ACCIAIO inox	GRIGIO	2piastre + 2viti	1
	SDCON4 collegamento tra profili	ALLUMINIO	GRIGIO	1piastra + 1vite	1
	SDMOLLA	METALLO	GRIGIO	1 MOLLA	1

ACCESSORI per PROFILI LED

CODICE ARTICOLO	DESCRIZIONE	PORTATA	DIMENSIONE	IMBALLO
SDBOX6	SCATOLA DI DISTRIBUZIONE a 6 vie per connettori MINI	PORTATA MAX 3A ogni presa	52X32X17 mm	1

CODICE ARTICOLO	DESCRIZIONE	PORTATA	ANGOLO	DIMENSIONE	INGRESSO	IMBALLO
SDTOUCH1	SENSORE TOUCH	PORTATA MAX 30W (led)	120°	--	12Vdc	1
SDTOUCH2	PULSANTE ON/OFF	PORTATA MAX 30W (led)	--	presa 150 mm	12Vdc	1

CODICE ARTICOLO	DESCRIZIONE	LARGHEZZA	PIN	IMBALLO
LED7500	CONNETTORE waterproof	--	4PIN	1
LED9000	CONNETTORE waterproof	8mm	2PIN	1
LED9500	CONNETTORE waterproof	8mm	4PIN	1

CODICE ARTICOLO	DESCRIZIONE	LARGHEZZA	CAVO	PIN	IP	IMBALLO
C2P-8	CONNETTORE SMD3528	8mm	14mm	2PIN	65	1
B2P-8	CONNETTORE SMD3528	8mm	--	2PIN	30	1
C2P-10	CONNETTORE SMD5050	10mm	14mm	2PIN	65	1
B2P-10	CONNETTORE SMD5050	10mm	14mm	2PIN	30	1
C4P-10	CONNETTORE SMD5050 RGB	10mm	14mm	4PIN	65	1
B4P-10	CONNETTORE SMD5050 RGB	10mm	--	4PIN	30	1



STRISCE LED



FONDO bianco CON ADESIVO 3M



CODICE ARTICOLO	Q.TA' LED	TIPO LED	RESA luminosa	LUMEN	KELVIN	IP	ANGOLO	LARGHEZZA striscia	VOLT	BOBINA	IMBALLO
LED100	60led/m	SMD3528	24W	1800/5m 6lm/led	3000	54	120°	8mm taglio ogni 49,5mm	12V dc 1,4A	5mt/ 300LED	1
LED200	60led/m	SMD3528	24W	1800/5m 6lm/led	6000	54	120°	8mm taglio ogni 49,5mm	12V dc 1,4A	5mt/ 300LED	1
LED400	60led/m	SMD3528	24W	1800/5m 6lm/led	6000	67	120°	8mm taglio ogni 49,5mm	12V dc 1,4A	5mt/ 300LED	1

FONDO bianco CON ADESIVO 3M



LED500	120led/m	SMD3528	48W/m	3600/5m 6lm/led	3000	67	120°	8mm taglio ogni 49,5mm	12V dc 1,4A	5mt/ 600LED	1
LED600	120led/m	SMD3528	48W/m	3600/5m 6lm/led	6000	67	120°	8mm taglio ogni 49,5mm	12V dc 1,4A	5mt/ 600LED	1
LED700	120led/m	SMD3528	48W	3600/5m 6lm/led	3000	54	120°	8mm taglio ogni 49,5mm	12V dc 1,4A	5mt/ 600LED	1
LED820	120led/m	SMD3528	48W	3600/5m 6lm/led	6000	20	120°	10mm taglio ogni 24mm	12V dc 1,4A	5mt/ 600LED	1

FONDO bianco CON ADESIVO 3M



LED900	60led/m	SMD5050	72W	5100/5m 17lm/led	3000	54	120°	10mm taglio ogni 50mm	12V dc 1,4A	5mt/ 300LED	1
LED1000	60led/m	SMD5050	72W	5100/5m 17lm/led	6000	54	120°	10mm taglio ogni 50mm	12V dc 1,4A	5mt/ 300LED	1
LED1020	60led/m	SMD5050	72W	5100/5m 17lm/led	6000	20	120°	10mm taglio ogni 50mm	12V dc 1,4A	5mt/ 300LED	1
LED1100	60led/m	SMD5050	72W	5100/5m 17lm/led	3000	67	120°	12mm taglio ogni 50mm	12V dc 1,4A	5mt/ 300LED	1
LED1200	60led/m	SMD5050	72W	5100/5m 17lm/led	6000	67	120°	12mm taglio ogni 50mm	12V dc 1,4A	5mt/ 300LED	1

FONDO bianco CON ADESIVO 3M



LED1400	240led/m	SMD3528	96W	7200/5m 6lm/led	3000	54	120°	14mm taglio ogni 25mm	12V dc 1,4A	5mt/ 1200LED	1
LED1500	240led/m	SMD3528	96W	7200/5m 6lm/led	6000	54	120°	14mm taglio ogni 25mm	12V dc 1,4A	5mt/ 1200LED	1
LED1600	120led/m	SMD5050	144W	10200/5m 17lm/led	3000	54	120°	14mm taglio ogni 25mm	12V dc 1,4A	5mt/ 600LED	1
LED1620	120led/m	SMD5050	144W	10200/5m 17lm/led	3000	20	120°	14mm taglio ogni 25mm	12V dc 1,4A	5mt/ 600LED	1

FONDO bianco CON ADESIVO 3M



LED1300	60led/m	SMD5050	72W	5100/5m 17lm/led	RGB	67	120°	12mm taglio ogni 50mm	12V dc 1,4A	5mt/ 300LED	1
----------------	---------	---------	-----	---------------------	------------	-----------	------	-----------------------------	----------------	----------------	---



CODICE ARTICOLO	DESCRIZIONE	DIMENSIONI	POTENZA	INPUT	OUTPUT	IMBALLO
LED5000	CONTROLLER PER LED RGB	100X65X25mm	100W _{max}	12v dc	12v dc	1



CODICE ARTICOLO	DESCRIZIONE	LARGHEZZA	PIN	IMBALLO
LED7000	CONNETTORE waterproof per RGB	--	2PIN	1

*LE IMMAGINI SONO PURAMENTE INDICATIVE



MODULI LED 12V

VOLT: DC 12V

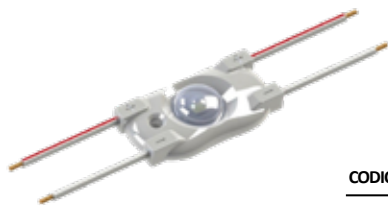

CODICE ARTICOLO	WATT	CORRENTE	LUMEN	KELVIN	ANGOLO	CRI	Q.TA' LED	n. elementi collegabili	IMBALLO
1600010	0,025W/PZ	0,1A/pz	27	6000-6500 bianco freddo	160°	≥75	4diodi	50	1



CODICE ARTICOLO	WATT	CORRENTE	LUMEN	KELVIN	ANGOLO	CRI	Q.TA' LED	n. elementi collegabili	IMBALLO
1600090	0,6W/PZ	0,05A/pz	50	6000-6500 bianco freddo	160°	>0.5	≥75	2diodi	50

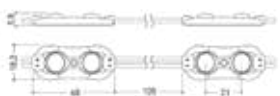

CODICE ARTICOLO	WATT	CORRENTE	LUMEN	KELVIN	ANGOLO	CRI	Q.TA' LED	n. elementi collegabili	IMBALLO
1600180	0,9W/PZ	0,075A/pz	80	6000-6500 bianco freddo	160°	>0.5	≥75	3diodi	40

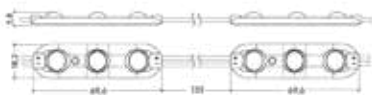

CODICE ARTICOLO	WATT	CORRENTE	LUMEN	KELVIN	ANGOLO	CRI	Q.TA' LED	n. elementi collegabili	IMBALLO
1040200104	1,2W/PZ	0,1A/pz	110	6000-6500 bianco freddo	1660°	>0.5	≥75	4diodi	30

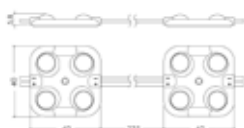



MODULI LED 24V

VOLT: DC 12V



CODICE ARTICOLO	WATT	CORRENTE	LUMEN	KELVIN	ANGOLO	CRI	Q.TA' LED	n. elementi collegabili	IMBALLO
11.170	0,48W/PZ	DC 24V 0,02A/pz	58	6000-6500 bianco freddo	170°	80	1diodi	100	1

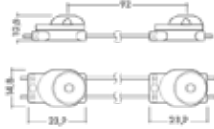

CODICE ARTICOLO	WATT	CORRENTE	LUMEN	KELVIN	ANGOLO	CRI	Q.TA' LED	n. elementi collegabili	IMBALLO
12.170	0,78W/PZ	DC 24V 0,032A/pz	115	6000-6500 bianco freddo	170°	80	2diodi	100	1

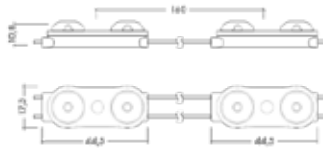

CODICE ARTICOLO	WATT	CORRENTE	LUMEN	KELVIN	ANGOLO	CRI	Q.TA' LED	n. elementi collegabili	IMBALLO
13.170	1,2W/PZ	DC 24V 0,05A/pz	150	6000-6500 bianco freddo	170°	80	3diodi	60	1

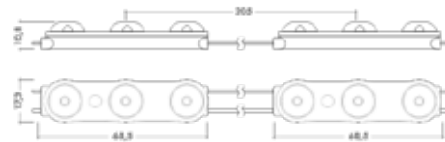

CODICE ARTICOLO	WATT	CORRENTE	LUMEN	KELVIN	ANGOLO	CRI	Q.TA' LED	n. elementi collegabili	IMBALLO
14.170	1,2W/PZ	DC 24V 0,05A/pz	180	6000-6500 bianco freddo	160°	80	4diodi	40	1

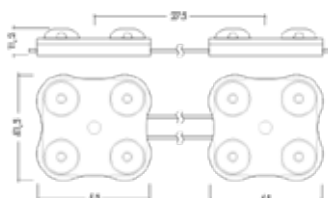





LED DRIVER



							CE	IP20
CODICE ARTICOLO	POTENZA	CARICO MAX	INGRESSO	USCITA	DIMENSIONI	IMBALLO		
ETUT2012	20W	20W	AC230V	12VDC	103X36XH16 mm	1		
UT24V-20W	20W	20W	AC230V	24VDC	128X50XH13 mm	1		



							CE	IP20
CODICE ARTICOLO	POTENZA	CARICO MAX	INGRESSO	USCITA	DIMENSIONI	IMBALLO		
UT12V-30W	30W	30W	AC230V	12VDC	155X53XH16 mm	1		
UT24V-30W	30W	30W	AC230V	24VDC	155X53XH16 mm	1		



							CE	IP20
CODICE ARTICOLO	POTENZA	CARICO MAX	INGRESSO	USCITA	DIMENSIONI	IMBALLO		
SNP50-12VF	50W	50W	AC230V	12VDC	160X57,8XH18 mm	1		
UT24V-50W	50W	50W	AC230V	24VDC	185X64XH22 mm	1		
DRIVER4248	52W	50W	AC230V	23-36VDC	190X75XH34.5 mm	1	USCITA DOPPIA PER COLLEGARE KITEMPL5365 PER EMERGENZA	



							CE	IP20
CODICE ARTICOLO	POTENZA	CARICO MAX	INGRESSO	USCITA	DIMENSIONI	IMBALLO		
SNP75-12VL-A	75W	75W	AC230V	12VDC	170X44.5XH28.2 mm	1		
SNP75-1400 IL	75W	75W	AC230V	27-54VDC	170X44.5XH28.2 mm	1		
SP75-1400 IL	75W	75W	AC230V	27-56VDC	170X44.5XH28.2 mm	1	DIMMERABILE	
ETQ8H24V75W	75W	75W	AC230V	24VDC	184X61XH32 mm	1		



							CE	IP67
CODICE ARTICOLO	POTENZA	CARICO MAX	INGRESSO	USCITA	DIMENSIONI	IMBALLO		
LPV/100/12AL	102W	100W	AC230V	12VDC	190X52XH37 mm	1		
LPV/100/24AL	100.8W	100W	AC230V	24VDC	190X52XH37 mm	1		



							CE	IP67
CODICE ARTICOLO	POTENZA	CARICO MAX	INGRESSO	USCITA	DIMENSIONI	IMBALLO		
SNP200-12VLP	180W	200W	AC230V	12VDC	180X31.2XH65.5 mm	1		



LED DRIVER MEANWELL

CE IP20

RSserie



CODICE ARTICOLO	POTENZA	INGRESSO	USCITA	DIMENSIONI	IMBALLO
RS15-12	15.6W	AC 85-264V DC 120-370V	10.8-13.2V	62.5X51XH28 mm	1
RS15-24	15W	AC 85-264V DC 120-370V	22-27.6V	62.5X51XH28 mm	1
RS25-12	25.2W	AC 88-264V DC 125-373V	10.8-13.2V	78X51XH28 mm	1
RS25-24	26.4W	AC 88-264V DC 125-373V	22-27.6V	78X51XH28 mm	1

CE IP20

LRSserie



CODICE ARTICOLO	POTENZA	INGRESSO	USCITA	DIMENSIONI	IMBALLO
LRS35-12	36W	AC 85-264V DC 120-370V	10.2-13.8V	99X82XH30 mm	1
LRS35-24	36W	AC 85-264V DC 120-370V	21.6-28.8V	99X82XH30 mm	1
LRS50-12	50.4W	AC 85-264V DC 120-373V	10.2-13.8V	99X82XH30 mm	1
LRS50-24	52.8W	AC 85-264V DC 120-373V	21.6-28.8V	99X82XH30 mm	1
LRS75-12	72W	AC 85-264V DC 120-373V	10.2-13.8V	99X97XH30 mm	1
LRS75-24	76.8W	AC 85-264V DC 120-373V	21.6-28.8V	99X97XH30 mm	1
LRS100-12	102W	AC 85-264V DC 120-373V	10.2-13.8V	129X97XH30 mm	1
LRS100-24	108W	AC 85-264V DC 120-373V	21.6-28.8V	129X97XH30 mm	1
LRS150-12	150W	AC 85-132V/170-264V DC 240-370V	10.2-13.8V	159X97XH30 mm	1
LRS150F-24	156W	AC 85-132V/170-264V DC 240-370V	21.6-28.8V	159X97XH30 mm	1

CE IP20

RSPserie



CODICE ARTICOLO	POTENZA	INGRESSO	USCITA	DIMENSIONI	IMBALLO
RSP200-12	200.4W	AC 88-264V DC 124-370V	12V	215X115XH30 mm	1
RSP200-24	201.6W	AC 88-264V DC 124-370V	24V	215X115XH30 mm	1
RSP320-12	320.4W	AC 88-264V DC 124-370V	12V	215X115XH30 mm	1
RSP320-24	321.6W	AC 88-264V DC 124-370V	24V	215X115XH30 mm	1



Corel s.r.l.

Via Triumplina 28 - 25123 Brescia - Italy

T. + 39 030 293006 - info@corelitaly.it

www.corelitaly.it

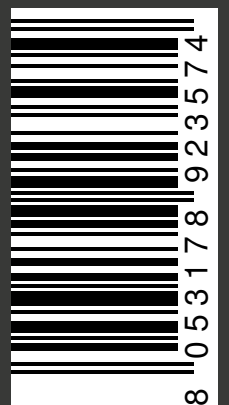

8 053178 923574
CATALOGO COREL LIGHTING 1/2025